

EZTouch Since 2001



MADE IN AMERICA

No Tariffs or Supply Chain Issues, Stable Prices

EZ3 Enhanced HMI

Most Advanced EZTouch

Costs Less Than EA9 & EA7
C-more, Made in China

Call or text Application Hotline at 563-726-1359 or Email EZ3EE@EZAutomation.net

Complete Specs

Product Videos

Starter Kits

All purpose Registration: Free downloads, additional discounts, + more

Only HMI available in

Sunlight Readable models 6" & 10"

Same day FREE SHIPPING if Ordered by 6 p.m. CST

EZ3 EE from EZAutomation Made in America		EA9 from AutomationDirect Made in China		
7"	\$549	7"	\$799	46% Higher
8"	\$1049	8"	\$1383	32% Higher
10"	\$1349	10"	\$1778	32% Higher
12"	\$1499	12"	\$1545	3% Higher
15"	\$1999	15"	\$2803	40% Higher

C-More Made in China

Surrounding Air Temp:50°C

INPUT:12-24V Max.16W Class2

Date code :707B

MADE IN CHINA



EA9-T6CL-R+17713B041

HERE'S WHAT YOU GET WITH EZ3 ENHANCED:

- **FULLY LOADED!**
- 400 Nits, 75K Hours @ 55C
- 65K colors
- 2 Serial Ports
- Ethernet
- 2 USB
- microSD
- .090" Thick Touchscreen
- C-Level Scripting
- Email/Tech Alerts
- Data Logging
- Remote Monitoring and Control over Internet or Smart Phones
- Unicode for Multiple Languages
- On Screen Recipe Edit
- Real Time Access to Process Data Stored Inside
- View Multiple HMIs in Multiple Plants using EZPlantview Software
- Full Project Simulation on your PC
- On Screen Recipe Edit
- Unique Visibility Tag for Best Screen Space Utilization
- Most Advanced Alarm Management and Logging
- Free Chart Recorder
- Unicode for Multiple Languages
- **Communication with DH+/Remote IO from Rockwell**

FREE Program Conversion from EA9 to EZ3 on orders over \$10,000

PROGRAMMING SOFTWARE \$149 FREE for Existing EZTouch Users

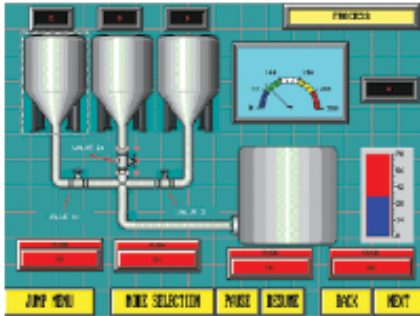

Programming so EZ and Intuitive, that even your CEO can do it in minutes

Program this screen in less than 10 minutes.
No training classes required.

FEATURES NOT AVAILABLE ELSEWHERE

1. Patented On-Line HMI Screen Edit Allows HMI Program Edit with Zero Downtime

2. EZ mini Wifi Allows Program/Edit from 50ft away without Programming Cable.

Screen Updated in Blink of an Eye

Edit Panel Online

No System Shutdown. No Downtime.

Watch it in action



3. OEM Utility Allows Field Upgrade of User Program over Email or FTP Server without the need of Programming Software

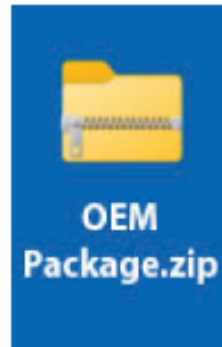

4. Superior Quality: Each Unit Goes Through a 24Hr Burn-in at an Elevated Temperature of 50°C as well as a HASS (Highly Accelerated Stress Screening).



SUGGESTED CALL TO ACTIONS

ORDER STARTER KIT

7" \$549

Includes: EZ miniWifi, Programming Software, Programming Cable, 60W Power Supply

DOWNLOAD
EZ3 FEATURES &
SPECIFICATIONS



ORDER FREE KTD (KNOWLEDGE TREASURE DRIVE)

With 360°Views, Selection Guides, FREE Demo Softwares, Video Tutorials, Real-life Programs. You Can Use Part Number Links that Connect you Directly to Web Store to make your purchase. If you're a New Customer or you've a New Application, our Application Engineers need a little more information. *It'll take you 3 mins or less to fill out the form.* U.S. and Canadian Customers only.

Download MADE IN AMERICA Articles:



[Benefits of Buying Made in America Automation Products that May Not be Readily Apparent](#)



[Why Made in America Should Be A Top Priority of Every American?](#)

Text 563-726-1359 or Email: EZ3EE@EZautomation.net

Evolution of Backlights in Human Machine Interface (HMI) Panels

From CRT displays to CCFL backlit Liquid Crystal Displays (LCDs), and now White LED backlit LCDs, touchscreen HMI's or Operator Interfaces have come a long way since its introduction in the early 90's.

Understanding the technology behind an HMI is very important when deciding which one to use. Parameters such as the life of the display, the quality of the picture, and the brightness of the display all come in to play when deciding which HMI will best suit the application and in particular its environment. Modern HMIs with LCDs are made up of several components. One of the most significant components with the LCD is its first layer which is the backlight. Backlights of the LCD are responsible for the light emanating from the screen. When flat panel LCDs replaced the older CRT displays like the ones used in older Panelview 1200's and 1400's, there was a significant advancement in each of the above noted parameters. LCDs with a Cold Cathode Fluorescent Lamp (CCFL) backlight tremendously enhanced the quality, brightness and life-span of the HMIs as compared to the old CRT Displays. However, you might be surprised that LCDs with a CCFL backlight started out with a life-span of roughly only five thousand hours. The CCFL backlit LCDs improved over time going from ten, to fifteen, to twenty, all the way up to fifty thousand hours of backlight life. Of course, the life-span of CCFL backlit LCDs depends on the temperature and humidity in which the HMI is sitting at. CCFL backlit LCDs operating at 25°C (77 °F) can normally last about fifty thousand hours, but the life of the backlight dramatically changes as the temperature varies. For example, if the temperature of the LCD rises to about 40°C (104°F), the life of the CCFL backlight deteriorates to roughly 20k hours. (See Figure 1).

As for relative humidity and its role in the life-span of a CCFL backlit HMI, its "wet bulb" temperature is normally rated at 39°C (102.2 °F). Once CCFL backlit LCD's reach its maximum humidity rating the backlight will give up (See Figure 2).

The evidence behind all this relates to how CCFL's work. The CCFL is a light source classified as an electronic component. The CCFL in simplest terms is a gas-discharge light source, which produces its output from a stimulated phosphor coating inside the glass lamp envelope. The typical CCFL is a hollow glass cylinder coated inside with a phosphor material composed of rare earth elements and sealed with a gettered electrode at both ends. (See Figure 3).

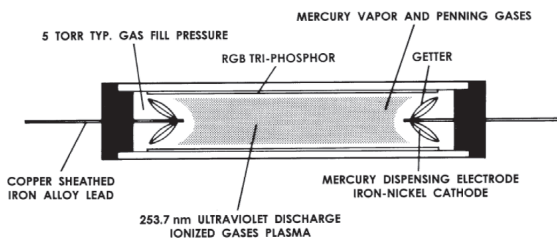

Figure 3: Make-up of CCFL

Ultraviolet energy at 253.7 nm is produced by ionization of the mercury and penning gas mixture by the application of high voltage to the electrodes. The UV energy from the mercury discharge stimulates the phosphor coating, thus producing light output. In short a CCFL can be described as a transducer

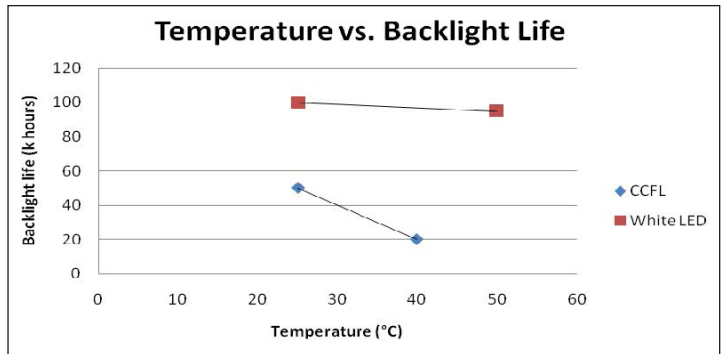

Figure 1: Comparison of CCFL vs. White LED Backlight life measured against Temperature.

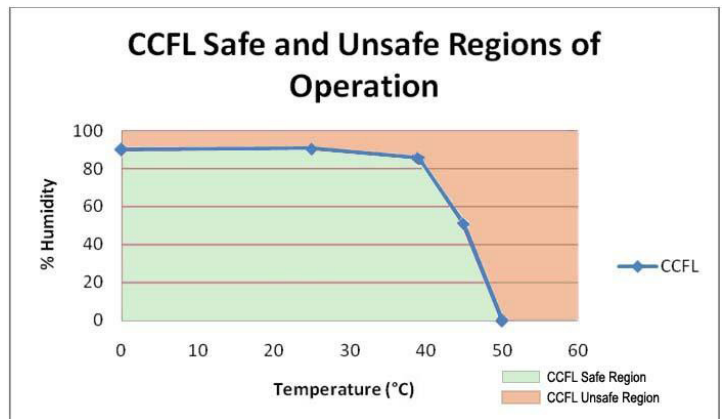

Figure 2: Relative Humidity Tolerance of CCFL Backlit HMI's. Note: Under the curve represents safe region and over the curve is the unsafe region of operation for CCFL backlit HMI's.

converting electrical energy into light energy. What one may not be aware of is the fact that in order to light up a CCFL backlit LCD, a supply voltage of over 1000 volts, typically 1200-1500 Volts is required. Conventionally the CCFL backlight is driven by an inverter board like the one shown in Figure 4 and is quite power hungry.

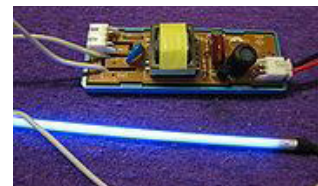

Figure 4: Example of a conventional CCFL inverter board and CCFL backlight bulb

Despite their name, cold cathodes don't remain cold as they operate; they can get painfully hot. This aspect of CCFLs can be quite problematic for CCFL backlit LCDs as this increases the backlight temperatures significantly thus reducing its life-span and at times causing erratic operation. Since nowadays, HMIs are shipped all over the world including India, Mexico, China, and the Middle East where ambient temperatures in some of these places reach 40° C (104° F) with a 90% humidity, these CCFL backlit HMIs can sometimes be problematic since they are not conducive to that type of environment.

White LED backlight brought by EZ Automation

White LEDs, light emitting diodes, are solid state devices that consist of a chip of semiconducting materials doped with impurities to create a p-n junction. As in other diodes, current flows easily from the p-side (anode), to the n-side (cathode). See Figure 5 for the general construction of an LED.

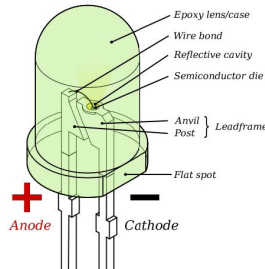

Figure 5: Parts of an LED

Unlike CCFLs, White LEDs do not have gases and phosphors that require high voltages to operate. In fact they can operate at voltages in the range of 5 to 24 Volts, and hence do not generate as much heat as compared to CCFLs. Due to its low voltage operation without the need of an intensive backlight inverter board, White LED backlit LCD displays generally last twice as long as compared to CCFL backlights with a standard life of anywhere from 75k to 100k hrs irrespective of the temperature increase (Refer to Figure 1). Furthermore, as compared to the 25 °C operating temperatures of a CCFL backlit LCD display, White LED based backlights tend to operate all the way up to 55°C (131°F) with humidity tolerances all the way up to 95% (See Figure 6).

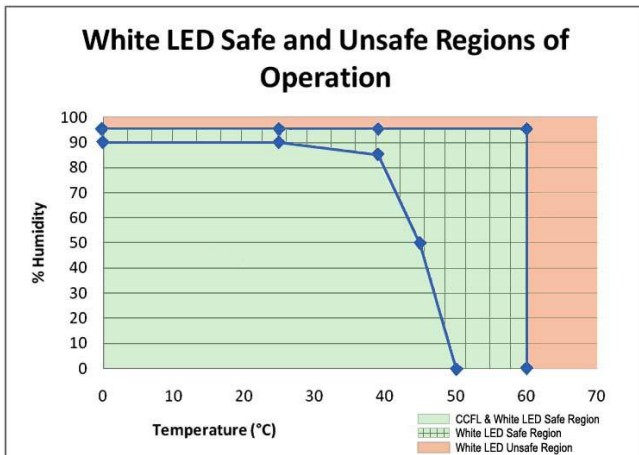

Figure 6: Relative Humidity Tolerance of White LED backlit HMI's.

Note: Areas under the plot represent a safe region where as area over the plot represent unsafe regions of operation for White LED backlit HMI's.

One of the key advantages of LED-based lighting is its high efficiency as measured by its light output per unit power input. Standard Touchscreen HMI brightness is often measured in the industry by the amount of NITS (lumens / sq feet). With White LED backlights, HMI's normally exhibit roughly 400 nits as compared to the CCFL backlit LCD displays at roughly 200-300 nits. Hence, with a white LED backlit LCD, not only does the life-span of the backlight increase two fold, the brightness of the display is also enhanced dramatically. Another important advantage of white LED backlit HMI's as compared to CCFL ones is the fact that if a CCFL bulb goes out, the entire LCD display is completely blacked out making it impossible for the operator

to read the HMI. With a White LED backlit HMI, if one of the many LED's burns out for whatever reason, the display may get dimmer but it can still be used for important machine operation. With HMI's being used in all different types of applications and environments both indoors and outdoors, these key advantages that the White LEDs have to offer over CCFL based backlights have become more and more important with today's operator interface choices.

In Touchscreen HMI's for industrial use, EZ Automation offers the only White LED HMI, with 75k hrs of life at 55°C and 95% humidity. It is the only HMI manufacturer that offers 4", 6", 8", 10" and 15" HMI's with White LED backlight, extending the typical life of an HMI to 8-10 years, as compared to 4-5 years at 35°C and 2-3 years at 50°C for HMI's with CCFL bulb.

All current HMI's from Automationdirect, Rockwell, Maple, Proface, Schneider, Siemens, Mitsubishi, Omron, Red Lion and others have CCFL backlight.

EZTouch®
Highest Value
HMI as chosen by
Control Engineers

EZTouch® since its introduction in 2001 has been voted by Control Engineers of North America as the Highest value HMI for its easiest to use programming software & dazzling graphics. Every year we have added new features to this product line, including White LED Backlight. Some of these features are highlighted below:

- » Pass-through programming to any PLC
- » Program upload from USB
- » Exclusive Data collection object - Store in USB
- » Remote Monitoring & Control
- » Safety/Redundant HMI feature built-in
- » Screen Print command for 21 CFR part 11 (FDA)
- » Exclusive on-line editing of HMI screen
- » Exclusive built-in Photo Editor
- » Almost universal connectivity including DH+ and RI/O
- » Free symbol factory, with 4000 symbols.
- » Object level password protection (up-to 8 levels)
- » Trending objects, such as line graphs, meters and bar graphs, also with floating point support
- » Fastest Screen Design » FDA compliant
- » Built-in antiglare screen » Animation objects
- » Project simulation » Modem support
- » Unicode Support » Visibility control over objects
- » Design protection for OEM/SI
- » Outdoor Readable Models
- » Event triggered Email notification
- » 2GB of local data storage on SD Card





Program this Screen in less than 10 minutes

EZ as 1-2-3

Innovate'n'Save™



EZTouch has earned it's name!

We named it EZTouch® HMI for a reason. We made an easy to use, simple operator interface that will save you a lot of engineering hours and design time due to its simplicity and ease of use. You don't need prior programming knowledge to design a screen. You do not need to attend any classes to learn how to program the EZTouch® HMI.

It is Intuitive, it is Simple!

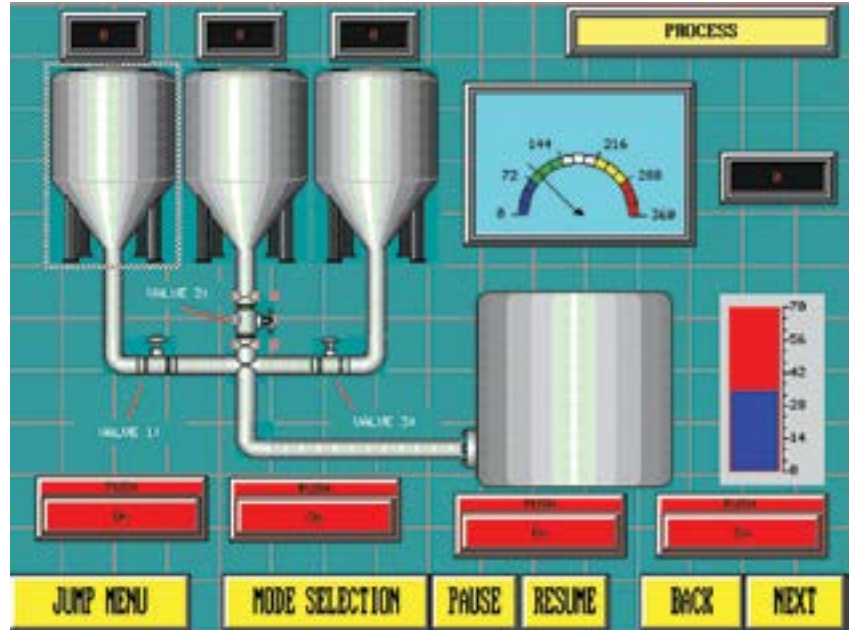

The only assumptions are:

- You are familiar with Windows-based environments
- You have a good understanding of your PLC memory's address formats

The following example shows just how EZ it is to create an object:

1

Select an Object

- Click on "Objects" on the main menu bar.
 - Select the object you wish to create. In this example, click on "Buttons => Switches".
- You may also select an object from the tool bar below the main menu.

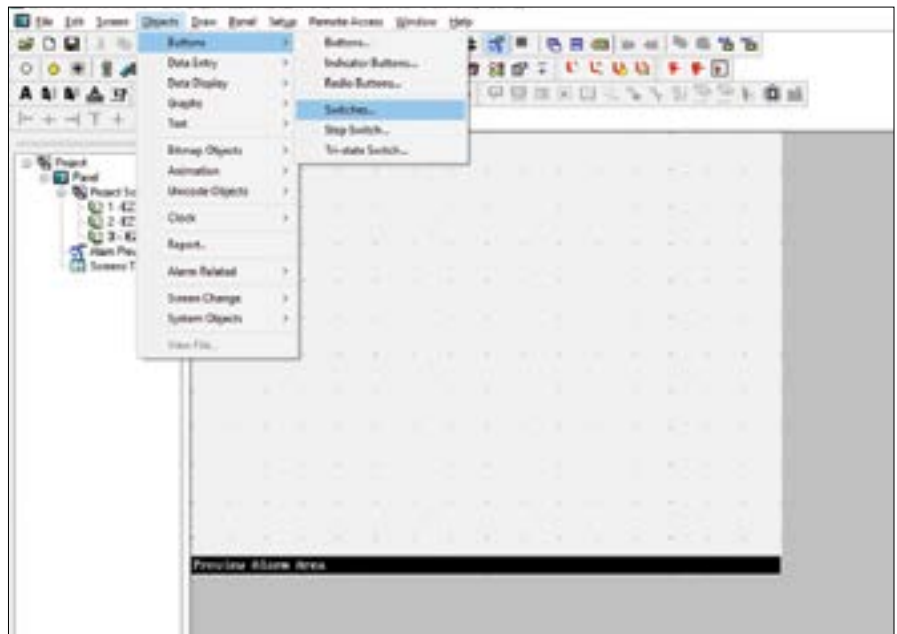

Tool Bar

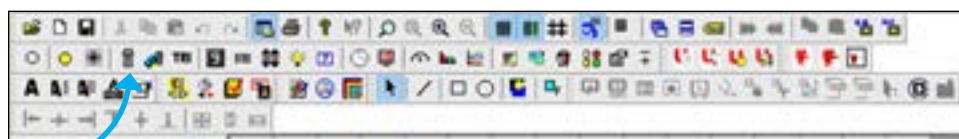

Or select switch object from the tool bar

Proudly Made in America

2

Fill in the Dialog Box

- A) Click the style of switch you wish to use.
- B) Select "Label Text". This will allow you to name and customize the object.
- C) Select or create a PLC bit address tag that the "Switch" will activate.
- D) If you need password protection, click on the "Protection" tab at the top of the dialog box.
- E) If you wish to keep this object invisible until a PLC tag is triggered, click on "Visibility/Details".

Visibility will be discussed later in detail.

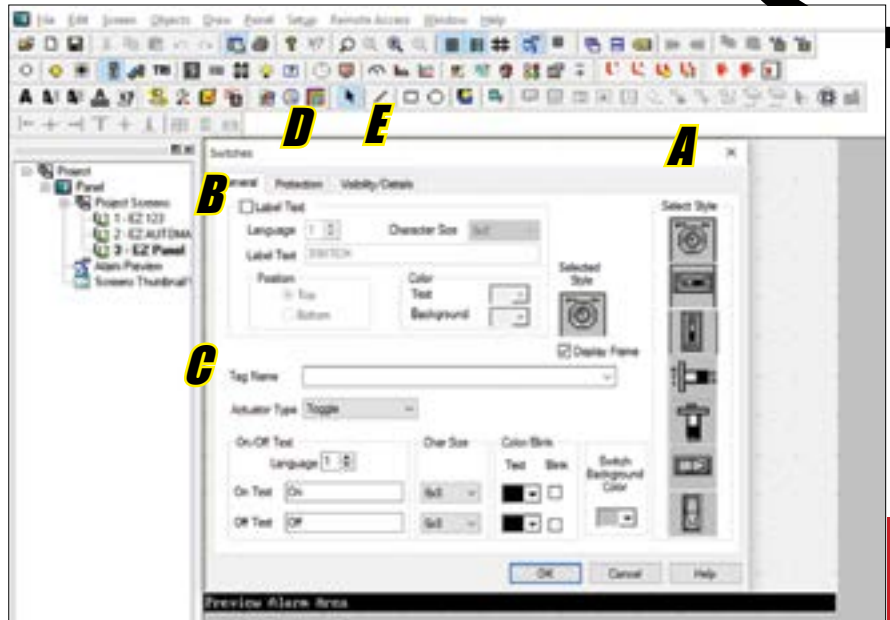

3

Placing the Object

Click your mouse on the screen and stretch the object to your desired size. If you want to edit the object again, simply double click on it and the configuration dialog box will reappear. There is even a "Simulate" button on the dialog box for some objects so you can see how objects will work in real time.

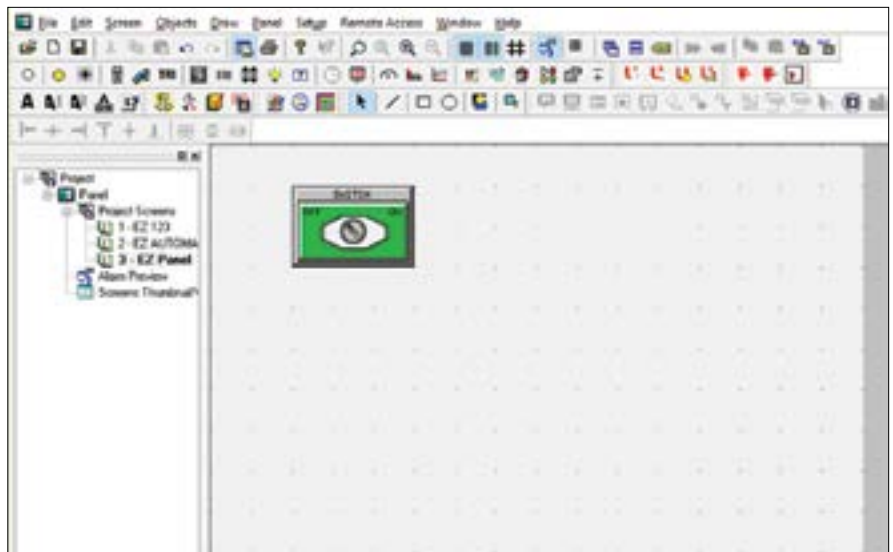

PERFORM THE PREVIOUS STEPS FOR DIFFERENT OBJECTS AND YOU HAVE DESIGNED YOUR SCREEN!

Designed from Ground up to Simply be the Eziest Software to Program Touch Panels

You do not have to spend \$1300 or attend a 3 day course to learn how to program an operator panel!

Allen Bradley recommends attending their course number RS-RSVMETR6 for developing skills needed to create and configure their panels even for small machine/process

EZ has widely been recognized as the Easiest to program software in the industry. More than 50,000 companies and over 200,000 Automation Control Engineers have used our software without having the need to attend even a one hour tutorial. In designing this product to be sold through the direct business channel without any local hand holding or training classes, we had to design this software to be so intuitive that even a first time user can get it up and running in a couple of hours without opening the software manual.

Proudly Made in America



Fastest Screen Design ... We Dare Compare!!

Most HMI vendors tout their programming software to be easy to use. So we offer you a challenge. If you can create the sample gauge faster than EZ can, with a competitor's software, we will give you our software 'FREE'

In survey after survey, the EZ Programming Software has been recognized as the EZiest to learn and use.



EZ Screen design challenge ...

So here is the challenge: Design a pressure gauge from one of the pre-built objects, select its range, select its color, design its label, transfer it to the real Touchpanel to see how it really looks, change its color, transfer it to panel again, change the font on its label and transfer it to the panel the third and the final time. Clock the time!!

We pre-defined the steps for EZTouch, C-More and Panelview, practiced the steps and had the same person do this exercise, here are the results...

EZTouch: 33.6 sec

C-More: 72.1 sec

Panelview: 186 sec

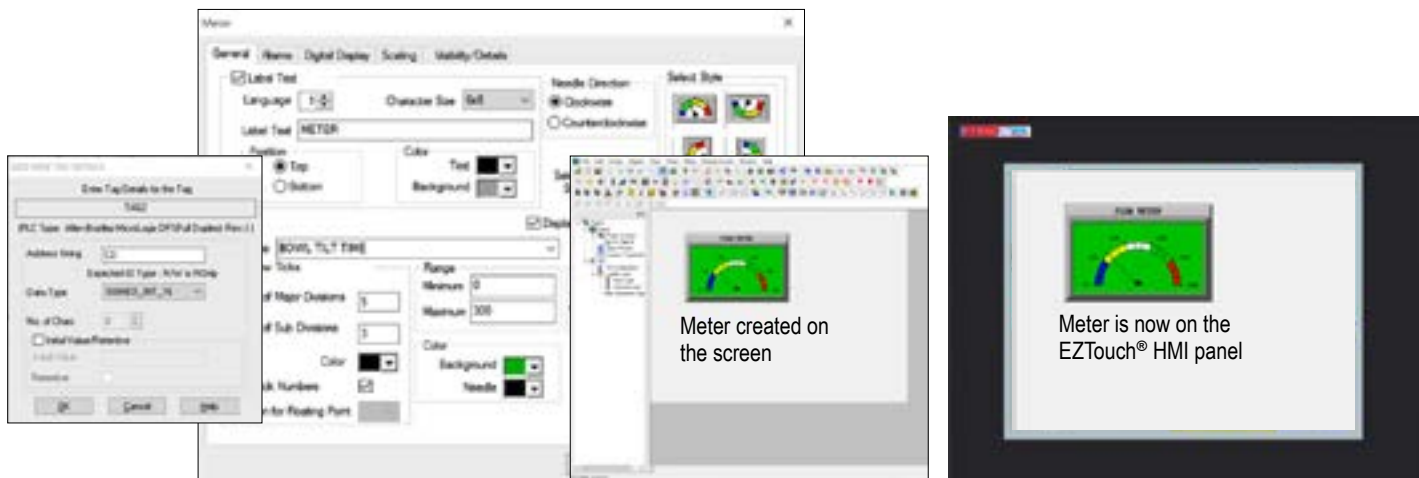

Beat "33.6 sec" and your software is "Free" *Innovate'n'Save™*

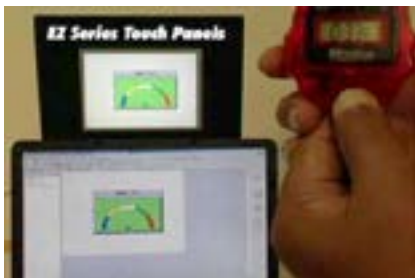

- The Cost for incorporating a PLC HMI Touchpanel in a project consists of

 1. Hardware Cost
 2. Programming Software Cost
 3. Time to Program / design the screens

Sometimes the 3rd cost far exceeds the first (hardware) cost.

For example, you may pay \$500 for the Touchpanel hardware, but it may take you three days to design the screens. At even a low rate of \$50 per hr., that will be \$1200 for screen design. Assuming the cost of software also to be a low number of \$99, the total cost of implementing the project will be \$1799. If the screen design time could be reduced to one day, the cost will come down to \$999, saving \$800 on the project!

Task / Cost	Ours	Theirs
1. Hardware Cost	\$500	\$500
2. Programming Software Cost	\$99	\$99
3. Time to program / design the screens	\$400	\$1200
Total	\$999	\$1799

EZTouch® HMI offers the lowest project implementation cost of any HMIs on the market
 Proudly Made in America

Start-Up New Application in Less than 1 Hour

Unique Online-Programming

THEIRS

1. Create Screen - 20 minutes
2. Compile and Download to Panel, minimum 5 minutes
3. Check it out on the Panel
4. Change colors, fonts, object sizes an average of 4 times, 5 minutes each

Time to develop and finalize one screen - 60 minutes

Create Screen



Compile... Download...
Compile... Download... and
Compile... and Download...
Compile... and... Download
Compile.....

60 minutes



Innovate'n'Save™

OURS

1. Create a couple of objects
 2. Click Save (also transfers to panel instantaneously) to see how they look on Panel
 3. Add more objects, click save again
- NO COMPILATION OR DOWNLOADS!**

Time to develop and finalize one screen - 10 minutes

Create Screen



**NO Compilation
or Download
Just Click and
Save to Panel**

10 minutes



**It's like developing screens
right on your panel**



**You know the power of
On-Line programming
if you deal with
machine/process start-up**

During machine start-up, you can simply plug your computer into Panel's Programming Port and:

- 1) Create a Troubleshoot screen
- 2) Create a troubleshoot button on main screen.
- 3) Disable critical outputs
- 4) Monitor registers and/or specific bits in your ladder logic... **without ever having to shut down the machine!**



**2 Create a temporary
Troubleshoot Screen in
"Edit On-Line" Mode**

**3 Troubleshoot without
ever having to shut
down the machine**

**1 Connect Computer
to Panel**

**Eliminates the need to go
through hundreds of ladder
rungs to troubleshoot the logic**

It's like having a FREE On-Line Debug Tool

Proudly Made in America



Compare Our Response Time and Screen Update Time

Patent Pending



Switch between screens in less than a second!



**TYPICAL
0.75 SEC**

and not 2-3 sec. like theirs

That's REALLY Fast!

We certainly won't lose panels due to Operators pounding on buttons!



Fastest Response to Touch Input

Because of the use of vector based graphics and a dedicated OS, EZTouch® are universally recognized as having the fastest response to touch inputs, typically less than 3/4 of a second even with complex screens. This means no waiting and also less wear on a panel from operators pounding an object on a screen waiting for a response.

Innovate'n'Save™



MAKING OPERATORS HAPPY

Proudly Made in America

EZTouch®, SENSIBLE and Operator Friendly

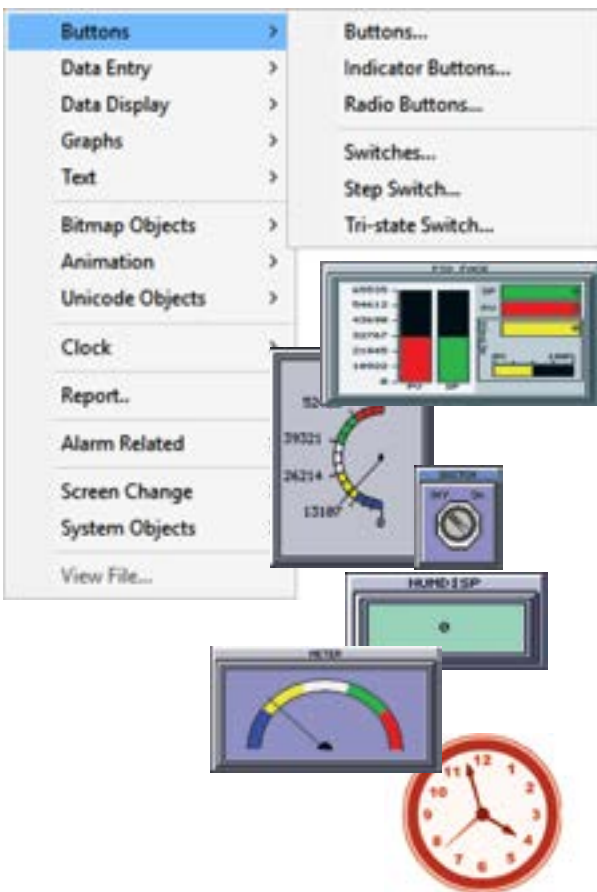

Dazzling Graphics & 65K Colors

Though extremely easy to configure, these touch panels are much more than push-button & pilot-light replacements. These panels provide high-end panel components & compelling real-life graphics that you would normally expect only on an expensive PC-based software HMI. Additionally, with 65K colors, blinking abilities, and extensive bitmap support, the unit offers dazzling graphics that would please any discerning user.

Pre-Built Panel Components (copyrighted)

In addition to pushbuttons, indicator lights, numeric entry and displays, the EZTouch® HMI offers panel components such as Analog Meters, PID Faceplates, Bar Graphs, Trend Graphs, Alarms, Recipes, Radio Buttons, Thumbwheels, a variety of Switches, and a rich library of Bitmaps.

Also, the user can select from a palette of 65K colors for all these components. Each color can be selected to blink in order to create components that will grab the operator's attention.



POP-UP Keypad allows you to enter data into a pre-defined PLC register.

Wide Range of Data Entry Tools

The EZTouch® HMI also comes with a wide range of data entry tools to allow an operator to easily enter both text or numeric data.

- A pop-up ascii keyboard, allows operators to enter part numbers and/or leave messages on the panel for another operator.
- A pop-up numeric keypad allows operators to set passwords, reset set-points and other data variables.
- Don't like numeric keypads? No problem, we also support pop-up thumbwheel switches, just like those old mechanical one's.



POP-UP Electronic Thumbwheel emulates a mechanical thumbwheel switch.

Proudly Made in America

Simple to Use, Yet Feature Rich

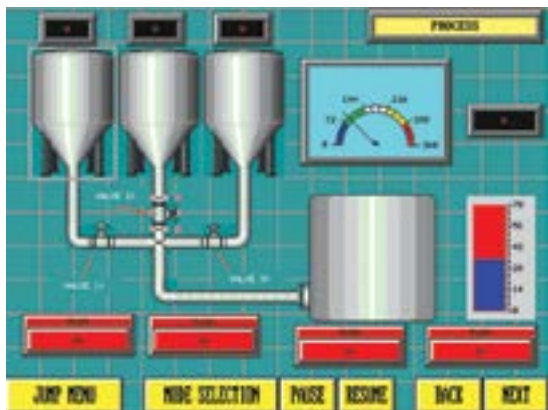

Freely Overlap and Size Objects

Freedom to overlap and size objects is now a standard feature of the EZTouch Programming Software. You can take any combination of the objects mentioned above and overlap them on the screen, which means an operator can stick to one screen without having to navigate through several screens to execute a specific operation. Also, objects on screen are no longer restricted to the touch cell grid and can be resized freely.

Innovate'n'Save™

Multiple Languages

With multiple language capabilities of EZTouch, you can now program the text for Panel components in up to 9-different languages. This means English reading operators can work with the panel in English, while the Spanish proficient operators can work in the Spanish language on the same panel. Also, with up to 9 different languages, OEMs exporting to other countries can develop programs to cover many of the commonly used languages.



Spanish and Chinese GUI

EZTouch® HMIs not only have multiple languages for operator messages, they have the option of panel setup as well as screen creation in Spanish and Chinese.



Multi-state Indicator & Bitmap Button

The multi-state indicators allow you to visualize process conditions, such as three states of a traffic light. EZTouch also offers Bitmap-based multi-state indicators, where you can use up to 256 bitmaps to indicate 256 different conditions. The bitmaps allow you to design very intuitive screens.

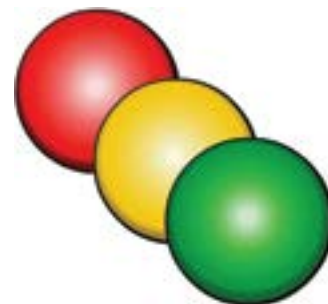

Password Protection

The EZTouch offers comprehensive alarming tools, allowing you to trigger alarms based on events (Bits) and values (registers), with the values being monitored for a variety of conditions (in/out of range). The alarm history also stores details of alarm counts where all this information can be printed or logged. Also, the EZTouch offers the flexibility of not only password protecting your alarms, but also every object.



Eight levels of password security for every input object.

Proudly Made in America

Real Time Animation Objects

Great for the machine operators to view and understand the tool motion, machine status or the whole process in real time

Single Position

How does a Single-Position Animation Object work?

Single position animation allows you to display a sequence of images at a fixed location on the screen. The images in the animation can be updated either periodically, using a numeric tag, or when a discrete tag changes state.

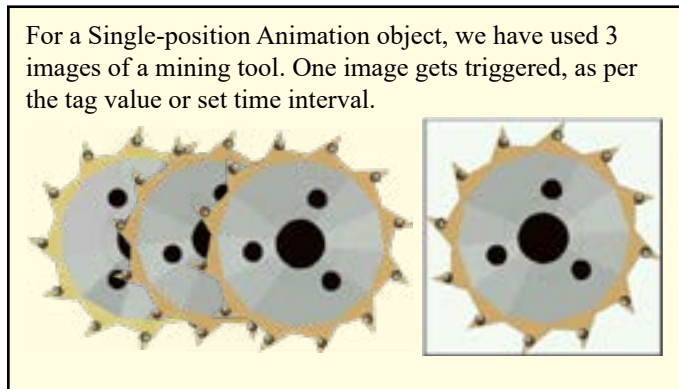

How to configure an animation object?

1. Select animation sequence control as to when the animation is triggered, either periodically (using a timed interval), using a numeric tag, or when a discrete tag changes state.
2. Select when animation occurs only once or continuously (loop control)
3. Select when to restart the animation sequence

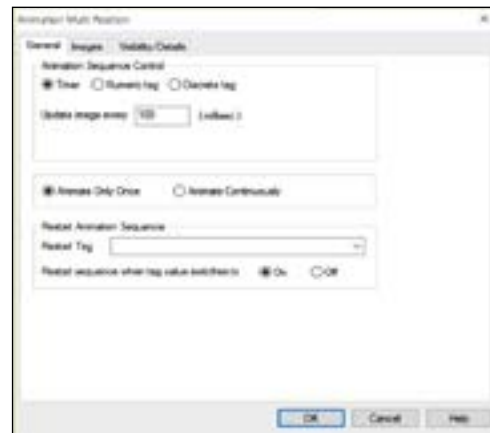

Multi Position

How does a Multi-Position Animation Object work?

Multi position animation allows you to display a sequence of images at different locations on the screen. The images in the animation can be updated either periodically, using a numeric tag, or when a discrete tag changes state.

An operator would know the condition of the machine based on the colored bitmap which is displayed. Each image is associated with a tag value.

State Awareness

Creating a visual representation of the process

How to add images to an animation object?

The images tab allows you to add images that are required for the animation object. Each image is automatically assigned an increasing index number. The index number determines the sequence of display of images in case of timed or discrete animation control. Of course, you may also set your own dimensions (WxH), and replace and remove the images from the existing image list.

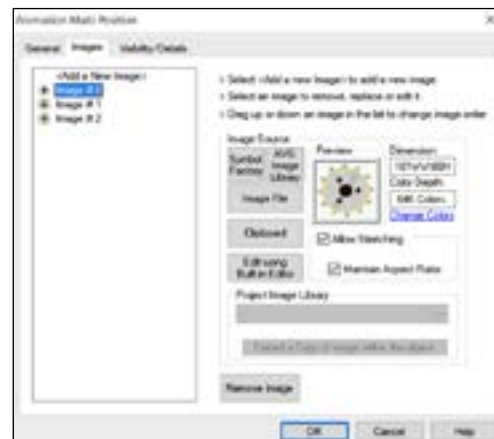

It's like animating process in real time

Unicode Universal languages

Great for the companies that are offering products to the international market

What are Unicode Objects?

Unicode objects are based on the Unicode Character Encoding System. There are four different types of Unicode Objects- Unicode Text, Unicode Indicator Lights, Unicode Indicator Buttons and Unicode Multi-state Indicator. These objects are exactly the same as their non Unicode counter part objects except with an ability to use international languages.

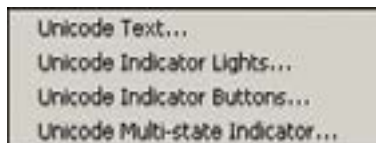

What is a Unicode System?

It is a character encoding system and can be used to create and place multilingual text using any font/script available on your PC.

Why use Unicode Text object vs. Static Text object?

Static Text object allows the user to display static text on a screen in only one custom font for EZTouch® with pre-set sizes of 6x8, 8x16, 8x32 etc., whereas with Unicode Text object, users can use any font in any size already installed on the user's PC. Unicode Text object also allows the user to enter static text in any supported International Language including complex script (e.g. Chinese) and right-to-left languages (Thai, Arabic etc).

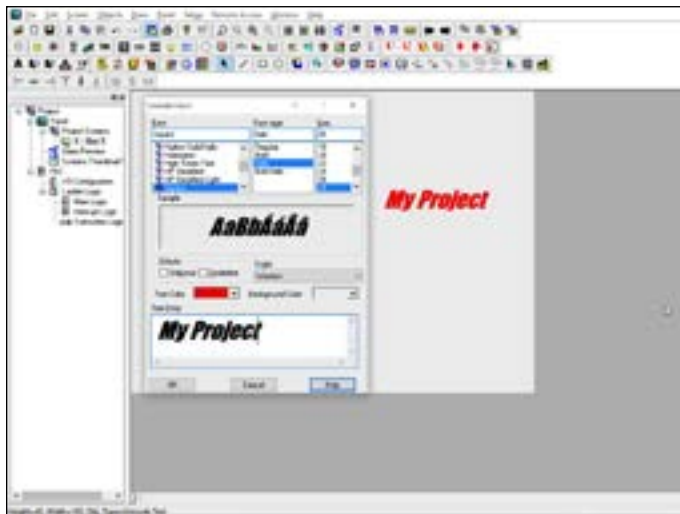

How to add Multiple Languages?

You may add different languages (Chinese, Hindi, Spanish, German, French, Japanese) to your PC through My Computer > Control Panel > Regional and Language options.

A language bar shows up on the task bar and makes it very easy to switch between the languages.

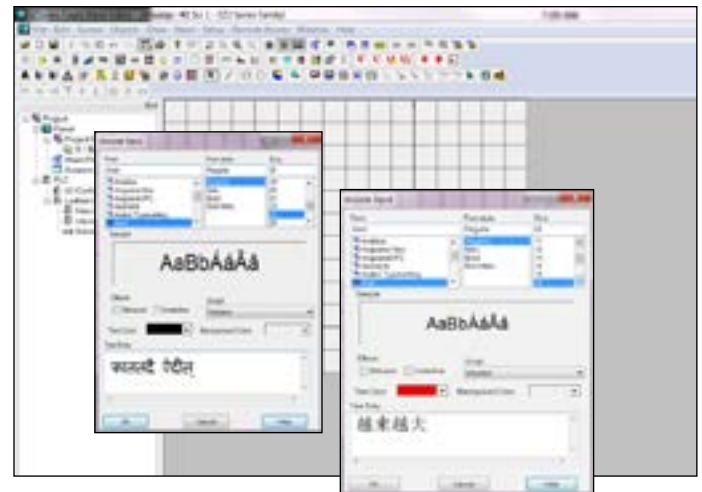

Further, Unicode allows the programmers to enhance the multi language capability of the touch panel objects.



Note: In order to enter text for South Asian languages (Thai, Vietnamese, Arabic etc requiring Cyrillic alphabet or right-to-left script) and Indic languages (Hindi, Tamil etc) you might need to install additional support on your PC. For entering text in East Asian languages (Chinese, Japanese etc) using U.S. keyboard you might need to install an additional Input Method Editor (IME).

Proudly Made in America

Advanced Alarm Management

Advanced Alarm Management System comprises Alarm Database, Alarm Preview, Alarm History, Alarm Count, Alarm Protection, Send Alarm to Marquee and a lot more.

Alarm Database

Alarm Database is a snap shot of all the alarms and their attributes. It allows the user to add new alarms, edit the existing ones and embed PLC Tags in the alarm text. Max limit of alarms is upto 999. Alarm database can also be imported/exported to excel.



Triggering Alarms

Alarms are triggered by the associated PLC Tags. Our panel has advanced capabilities to monitor the state/value of the PLC Tags. If your data type is DISCRETE, you will be able to select whether the alarm will be displayed when the bit is On or when the bit is Off., whereas if the data type is other than discrete, enter the limits (low or high) and define a set of condition(s) to activate the alarm.

Alarm Protection

Use the Alarm Protection feature to limit access to the Clear All or Clear buttons on the Alarm History and/or Alarm Count screens. Operator will have to enter a password on the popup keypad to be able to use them.

Position your Alarm messages anywhere on the screen

Alarm Preview

To preview and edit the alarm text. Modify the size, position and the background color of the alarm window.

Project Simulation

You may verify the functionality of an alarm on the PC itself, obviously even before transferring the project to the panel.

Alarm Count

The Alarm Count lists all the triggered alarms and shows the total count for each alarm in a given period.

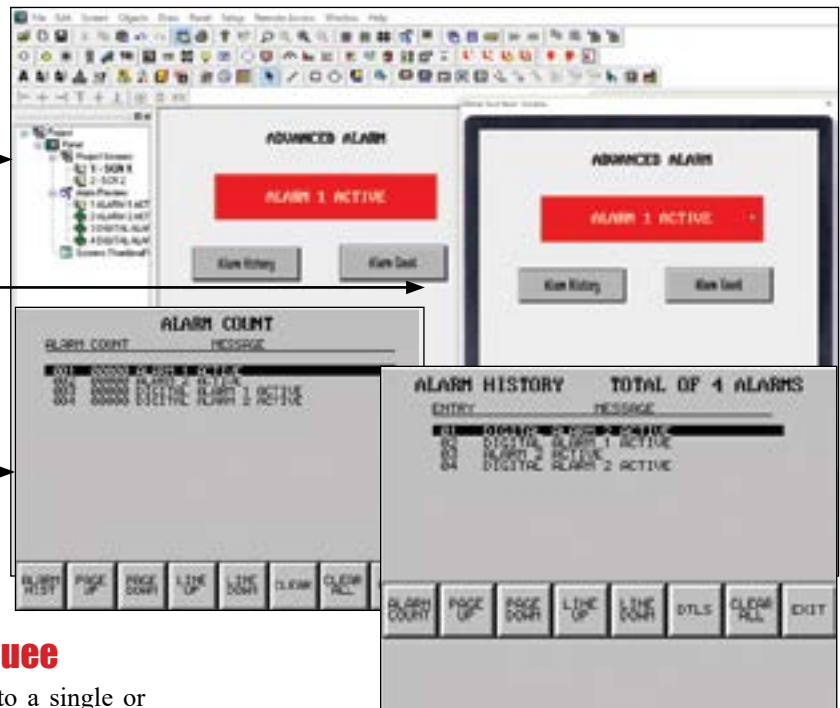

Send Alarm to Marquee

You may send the alarms to a single or multiple marquees connected to the RS232/422 port of the panel, just by configuring the COM1 port of the panel for PRINTER.



Alarm History

The Alarm History will show each alarm that has occurred with the most recent at the top. When you press the Alarm Detail button, you will get the Entry Number of the Alarm, when it was activated (time and date), when it was cleared, actual value, high/low limits, and which limit is tripped (HIGH/LOW/DIS). Alarm history can be exported/imported to excel.

Proudly Made in America

Email and Text Alarm Messages

Advanced Alarm Management System allows user to program and send emails and text messages to various recipients based on a triggered or scheduled event/alarm .

**NEW
Convenience
Features**



- 1** **Email Server Setup**
Program Authenticated or Unauthenticated Server details

- 2** **Alarm Email Setup**
Setup Content of Alert for Email or Text.

- 3** **Email Recipients**
Email recipients can be based on an ASCII tag address or a constant email address. The benefit of an ASCII tag address is that a user can modify the email on the HMI and NOT have to go to the programming software. (Useful feature for plant personnel change).

To send text messages, enter in the phone number under email recipient with the cell phone carrier they have.

Example: 630-555-5215@sprintpcs.com

- 4** **Schedule Email**
Emails Alerts can be programmed based on triggered events / alarms (Tag based), or scheduled timings. Certain messages can be programmed for individual recipients only (i.e. managers), while other messages go out to all plant operators/electricians. Messages can be programmed to specific times such as Shift Changes, Daily, Weekly, or Monthly.

Proudly Made in America

Unique Visibility Tags - Allows Objects to be Hidden for Maximum Utilization of Screen Real Estate

All objects have the unique ability to appear and disappear based upon both PLC tags, as well as internal tags. In the following example, we show one of the many ways Visibility Tags can be used to expand your screen.

1 Normal Run Mode

Operator does not have access to changing PLS setpoints.



Here is how one of our customers used visibility tags to reduce the number of screens by 30%!

2 Setpoint Edit Mode

PLC "PROG_MOD" Tag makes three additional objects appear on the screen. "ON POSITION", "OFF POSITION" and "Updating Setpoint" objects are programmed with "PROG_MOD" variable as their Visibility tag.

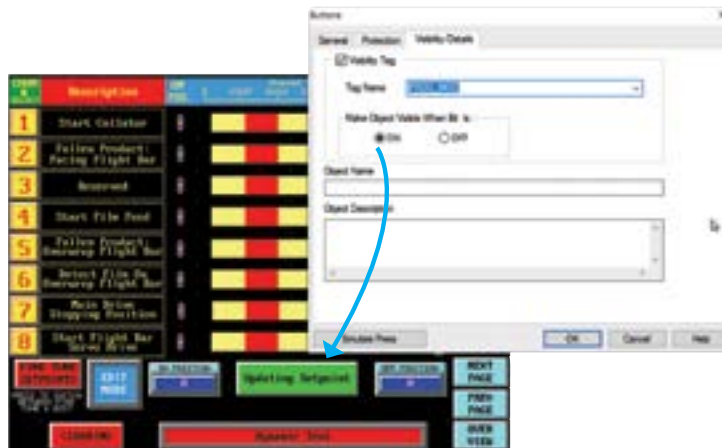

3 Fine Tune Mode

PLC "FINE_TUNE" Tag makes Fine tune objects replace the updating setpoint object. Panels without visibility tags would need screen real estate for both "PROG_MOD" objects and "FINE_TUNE" objects. Visibility tags thus save a tremendous amount of screen real estate. Its not unusual to reduce the number of total screens to half by virtue of this unique feature.



Innovate'n'Save™



EZTouch® Programming Software

Overlapping of Objects

Many times, an operator will want a great deal of information available on one screen at any given time. Getting all this information to fit, however, can be quite a task. Allowing objects to overlap is just one more way you can save a great deal of screen real estate.

Now you can overlap objects, for example a numeric indicator, on top of other objects such as dynamic bit maps or meters!

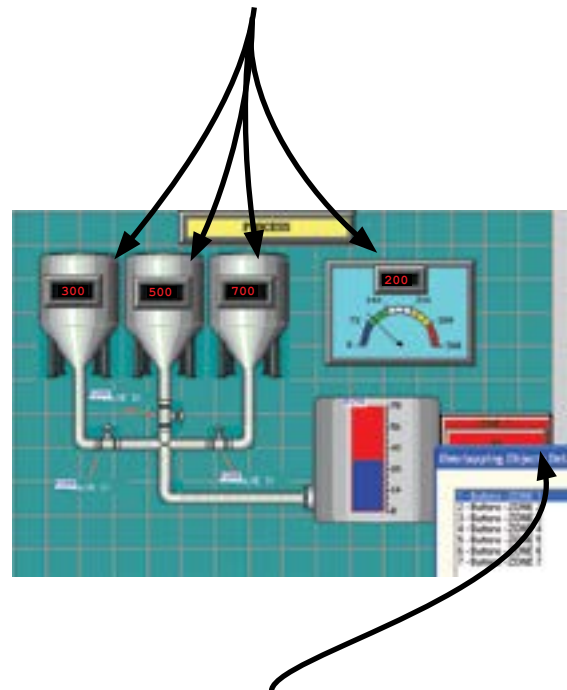
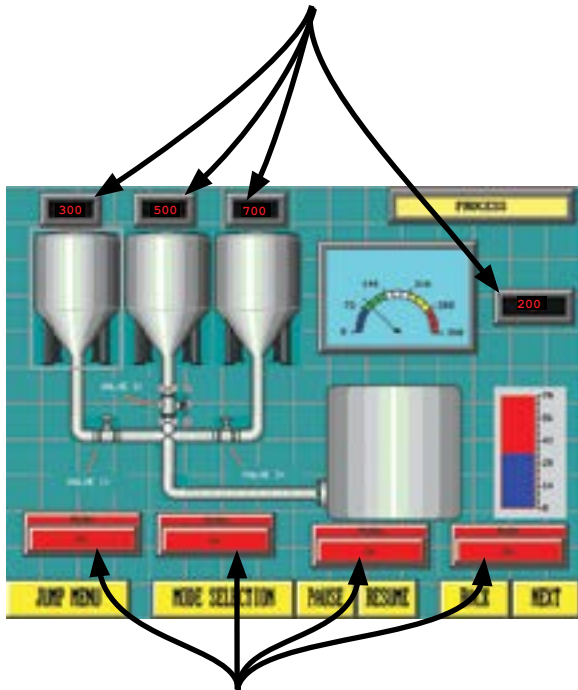

Recipe buttons can be overlapped to change up to 40 operations at a time.



Free Sizing of Touch Objects

EZTouch® HMI's Enhanced programming software allows the free sizing of all objects without snapping to the grid or the actual object itself snapping to certain dimensional sizes. You can make all objects as large or as small as you want them to be.





EZTouch® Programming Software

Easy as 1-2-3 Programming Software

EZTouch programming software is by far one of the easiest to use programs available in the market. You have seen a presentation of our powerful objects in the last few pages. Now let's take a look at how easy and simple it is to create an object.

The EZTouch programming software is just like any other windows application that comes with a main menu bar with pull-down menus, tear off toolbars with icons that have the hover-over description, a main window area where the screen is designed, etc. You can also build multiple screens at the same time and display them as tiled or cascaded in the main window, as shown in the examples to the right.

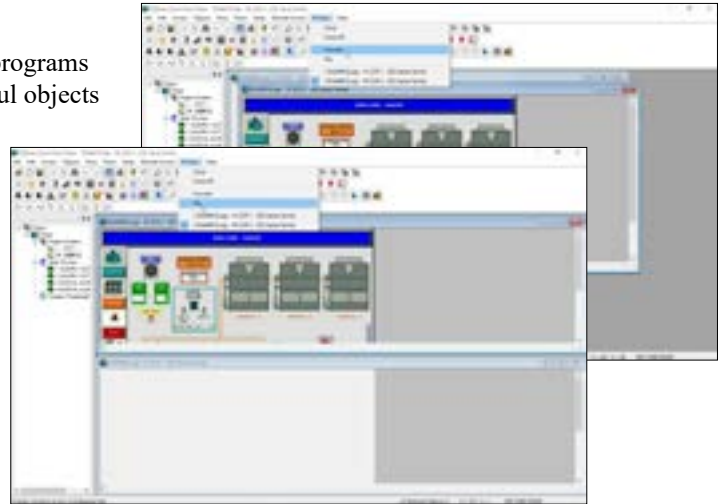

Toolbars and Icons

These toolbars, whether attached or floating, contain all the icons which represent the objects, which can also be selected through the main menu under Objects. Toolbars are fully customizable, and can be moved and resized to where you need them most. The example below shows how 3 floating toolbars (Basic Objects, Drawing Objects and Communication) have been created from pulling them away from under the main menu bar. The Communication toolbar below also illustrates how hovering over an icon will display a brief description. Click on an icon, and the associated dialog box will appear for you to begin building your object.

Main Menu Bar →

Project Screen Explorer → This side window displays the screens that you have created within your project. To open and edit a screen, simply double click the name of the screen. The book icons also let you know which screens are currently open.

Attached Toolbar ↑

Active Screen Window → The active screen window is where you design your screens or place objects. When you open a screen from the Project Screen Explorer, it opens in the active screen window and also displays at the top in the title bar.

Active Screen Window Options → Resize the window to represent the size of the panel, or zoom in while working. Turn on a grid or the snap to grid option to help align your objects when placing them. The background color, which also appears on the panel, is editable.

Floating Toolbar →

Minimum PC Requirements

- Pentium, 133 MHz, CD ROM
- 128MB RAM
- 130 MB free disk space
- WIN95/98/2000/NT4.0/XP/XP Pro/7/8
- Color SVGA 800x600 minimum 1024x768 recommended

Online Programming, Patented

Online program editing is one of the most powerful features of EZTouch panel. It lets you program your panel 'Online' without losing any precious time uploading and downloading projects to a panel. Just connect your panel to your computer, select online programming, edit, and save your entire project while your panel is online with a PLC.

In case you missed our illustration of just how important and powerful this feature is, please review pages 5-11 and 5-37 as it explains in detail this huge time saving feature!

Proudly Made in America

EZTouch® Programming Software

1 Using the Objects pull-down menu or an icon in the toolbar, select the object you want to create. In this example, we are creating an Indicator button.



It's as EZ as **1-2-3**
to Create an Object

2 Every object has an associated dialog box, as shown to the right. The different tabs at the top contain all the prompts for creating the object for your specific needs.

Object configuration dialog box (Options vary upon object selected)

Custom label your objects to ensure that the objects purpose won't be mistaken.

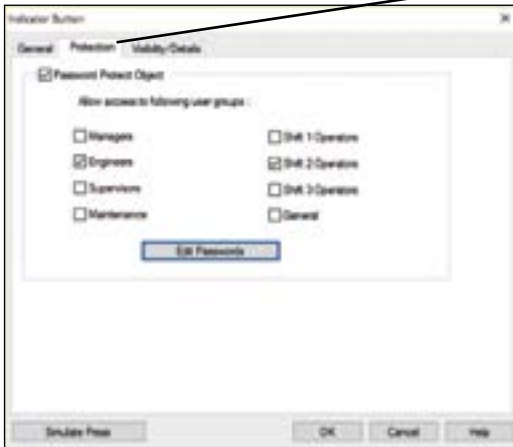

Password Protection

Allow only authorized users or certain groups the appropriate level of access with password protection, as shown above.

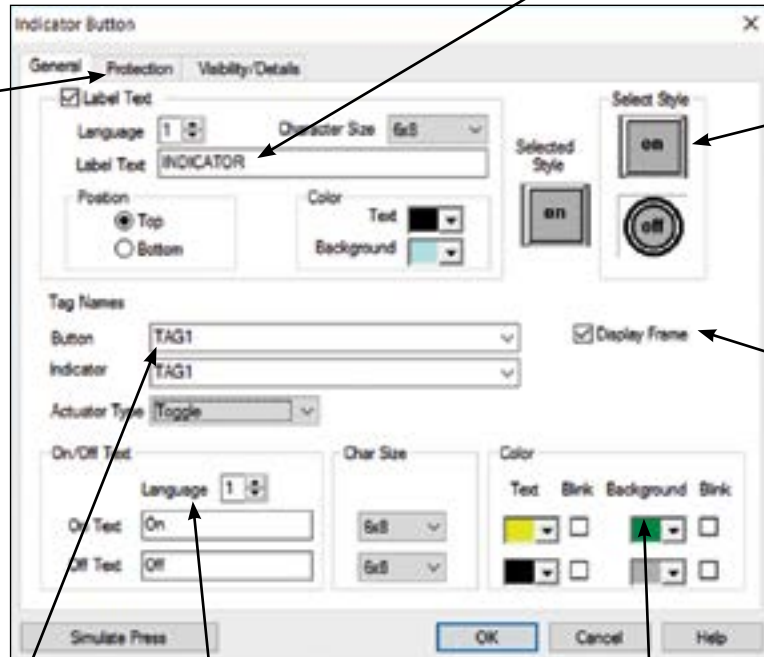

Select the style in how you want your object to appear on the screen.

Display frame gives an object that desired 3D appearance, which can help differentiate it as a button. (Example shown at step 3)

PLC Addressing

Type in the tagname and then right click on the name you just typed. This will bring up the dialog box to the right, to enter the appropriate PLC address string and data type, which determines how the object links to the PLC.



Color Palette

With 65K available colors for an object's text, background, label and more, making an object stand out or look as part of an organized grouping or category is easier than ever.

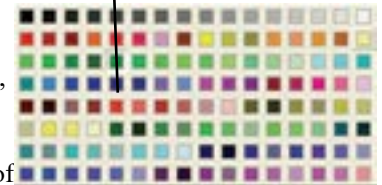

Nine Different Languages

With EZTouch® HMI's multiple language capabilities, you can now program the text for Panel components in up to 9-different languages. This means English reading operators can work with the panel in English, while the Spanish proficient operators can work in the Spanish language on the same panel. Also, with up to 9 different languages, OEMs exporting to other countries can develop programs to cover many of the commonly used languages.



3 Once you are done creating your object, simply click OK and then click on the screen. Resize and move your object as needed. If you feel an edit is necessary, no problem! Double click the object and the dialog box will reappear. It's that EZ!!



with Display Frame



without Display Frame

Proudly Made in America

EZSeries Programming Example

EZ as 1-2-3

1 The startup screen would provide you with options for creating and opening projects. First, choose the configuration mode: Edit offline, Read from Panel, Edit Online. Then enter your system parameters by typing in the fields or using the pull down menus.

Select the configuration method from our "Online, Read from Panel, and Edit Offline" options.

Enter system information and use the drop down box for correct selections.

Click OK when you're done!

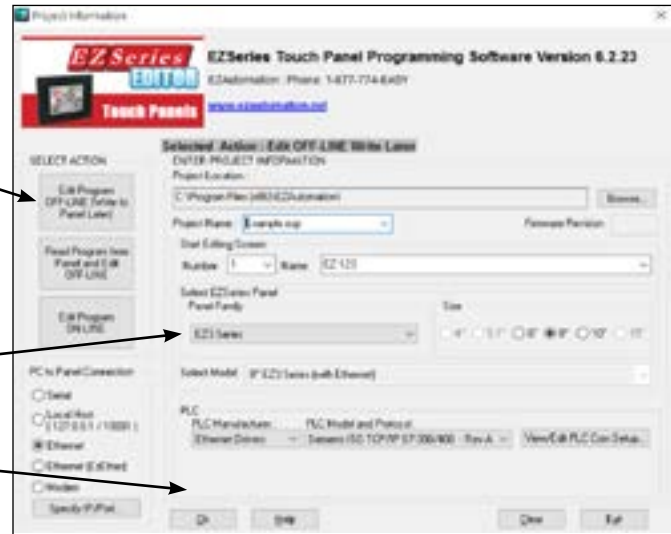

2 Once you select your options and your new/previously developed screen is open, you are ready to start creating your project using our easy to find toolbar or menu's.

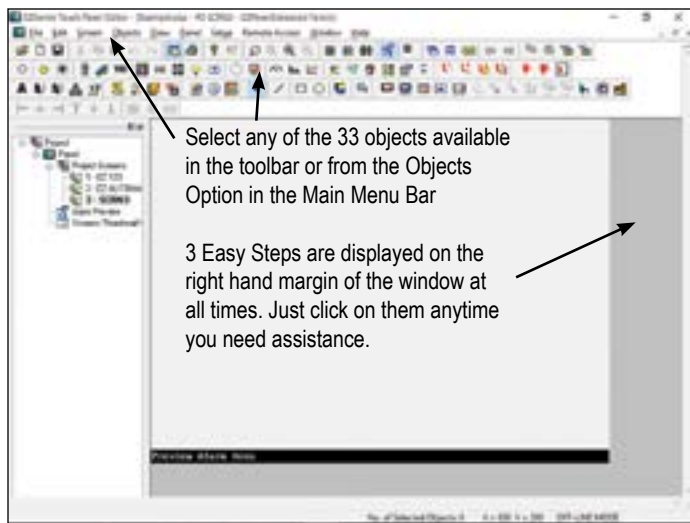

Select any of the 33 objects available in the toolbar or from the Objects Option in the Main Menu Bar

3 Easy Steps are displayed on the right hand margin of the window at all times. Just click on them anytime you need assistance.

Complete the Dialog box (on the right)

And the PLC assignment (below)

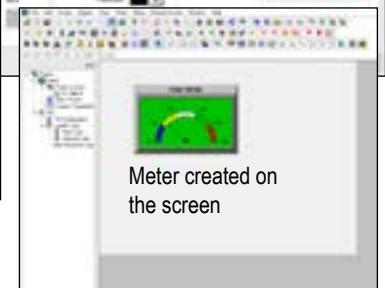

Meter created on the screen

3 Click the "Write Program to Panel" button, click OK, and you're done! Or just click Save if in Online Mode.

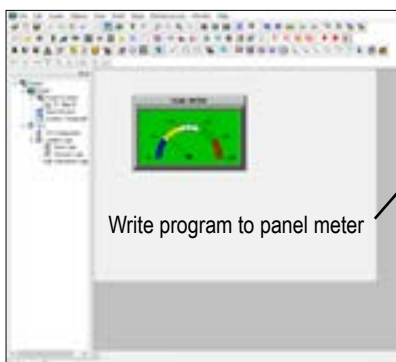

Write program to panel meter

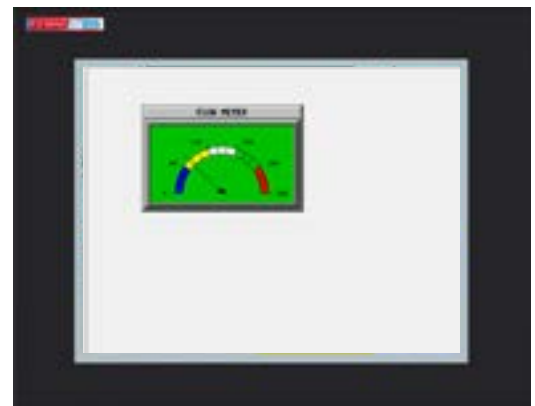

EZTouch® Alarm and Data Logging Features

**NEW
Convenience
Features**

EZTouch Programming Software is also compatible with the original EZTouch®. This enhanced programming software supports all the new PLC drivers as well as new convenience features requested by our customers.

Alarm Logging

Now with EZTouch® HMI Alarm Logging to USB port is just easy. Select the “Log to File” feature on the New Alarm setup window and save the alarms on the USB flash drive in .csv file format.

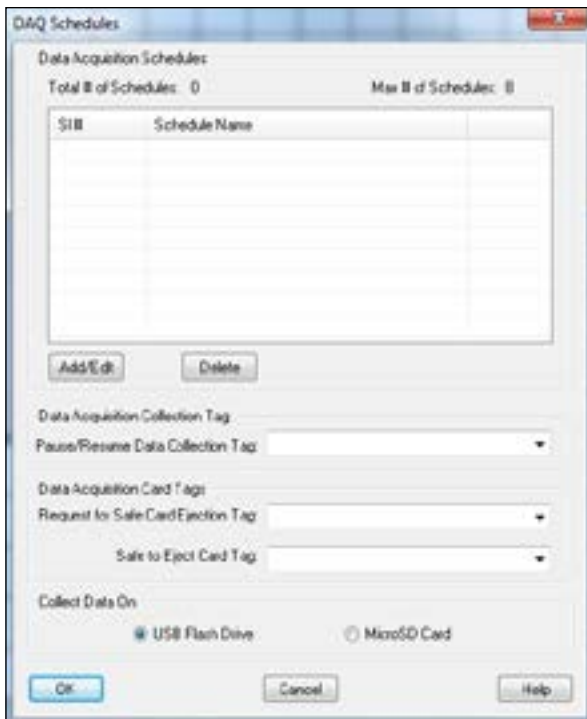

Data Acquisition on USB Flash Drive or Micro SD Card

EZTouch® HMI will schedule your Data Acquisition directly on to the USB flash drive or Micro SD card. This feature helps you collect the data from panel to PC at your convenience.

USB Program Uploader

This feature helps you save your entire project as a .hmi file which can now be copied on to the USB flash drive. When plugged-in to your EZTouch® HMI USB port the panel automatically transfers the program to the panel thus your panel is up and running.

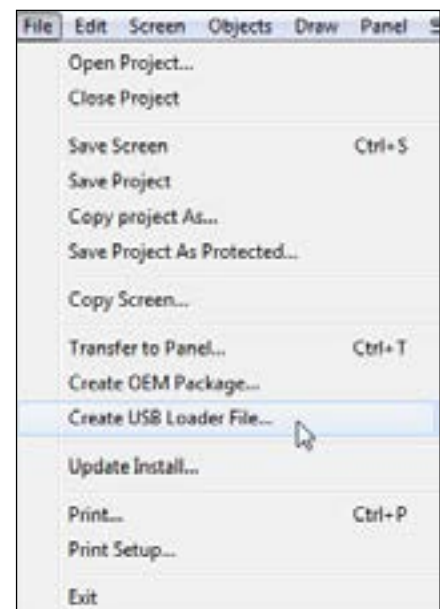

Proudly Made in America

New Updated Symbol Factory

**NEW
AVG Image Library**



- **Better image resolution when resizing objects**
- **Less memory consumption**
- **More detailed objects**
- **Larger variety**

Be Creative, Display Hi-Resolution Images



**Hi-Res
Colorful
Image Library**



Proudly Made in America

Eziest to Use Programming Software

Now with Built-in Photo Editor at no extra cost!!

The EZ Series Touchpanel editor has raised the bar further in HMI software by including an exclusive, advanced, patent pending, bitmap photo editor that allows any bitmap being imported (such as from the 4000 symbols library) to be edited almost like “Photoshop” within the EZ Software itself.

It eliminates the need to :

1. Have “Photoshop” or “MSPaint” program installed on your computer
2. Bring the bitmap into “Photoshop”, edit it and then import it back to the HMI program

Innovate'n'Save™

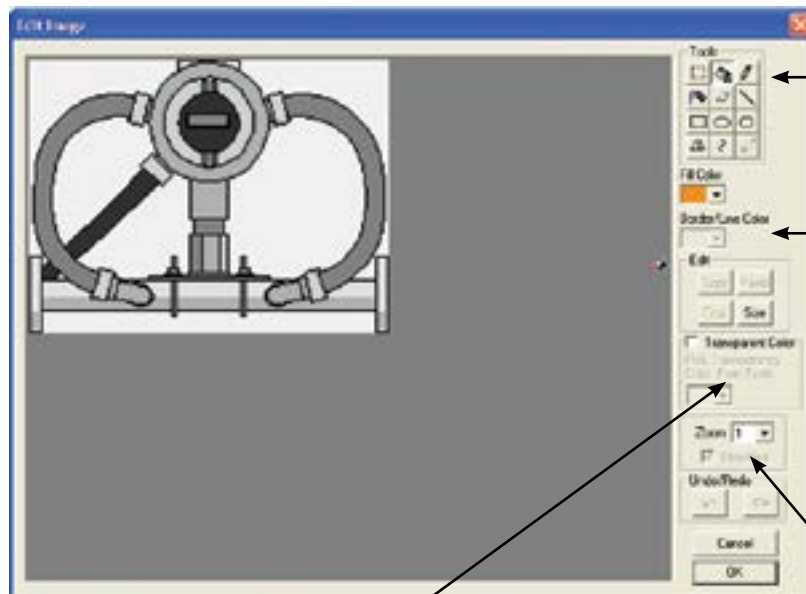
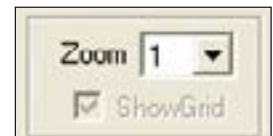
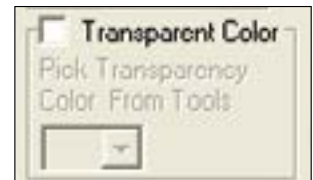

Built-In Shapes, Drawing Pencils, Spray Cans, Eraser and more ...

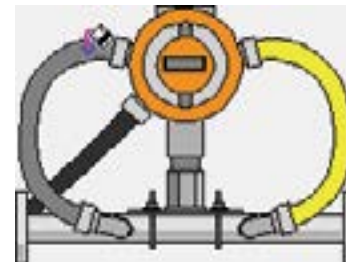

Fill Color

Fill the color on the bitmap of your own choice from the color palette.

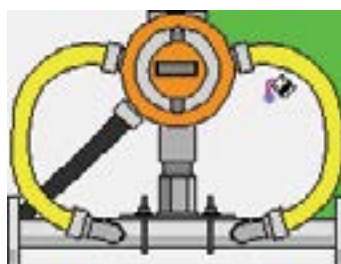

Transparent color

The transparent color is used to make all areas of that color which is the same as the fill color to be invisible or transparent.

In the above example the green fill and transparent color makes it invisible or transparent.

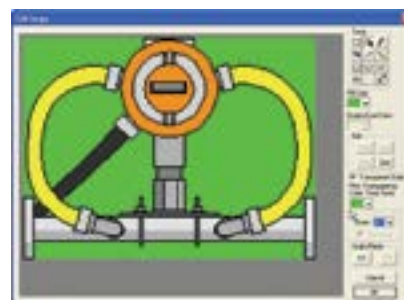

Zoom Tool

Zoom tool has 1 to 4 level, making edits in tight spots no longer a problem. For pixel-per-pixel level detail there is a zoom level 4

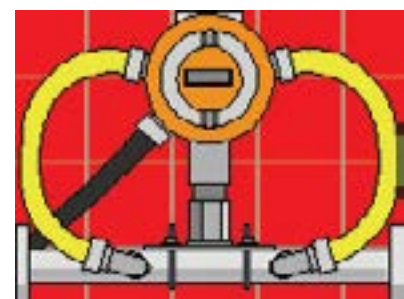

Final bitmap Image

The built-in photo editing feature in EZTouch software eliminates the need for photoshop on your PC

roudly Made in America

EZTouch® Programming Software

Innovate'n'Save™

Display of Tag Addresses on Objects

The PLC addressing uses Tag names, so that you can associate meaningful, easy-to-remember names to the addresses. Additionally, tags are useful if you use different PLCs with the same HMI program. You will only need to design the HMI program once! Then just change the tag definitions to match the PLC you have to use - a wonderful time saving feature!



The enhanced ability to display tag addresses on the objects allows EZier screen development and troubleshooting. Here we are showing the tag address for block transfer on AB's Remote I/O.

Pick and Apply Styles...

When designing screens, there are many attributes assigned to objects, such as object's colors, object's shapes, text sizes, text colors. All these details in completing a style for the screen takes a great deal of time. This feature allows the ability to "copy and paste" these styles from one object to as many as you select. Another wonderful time saving feature!

The object's style that was picked has now been applied to the other objects

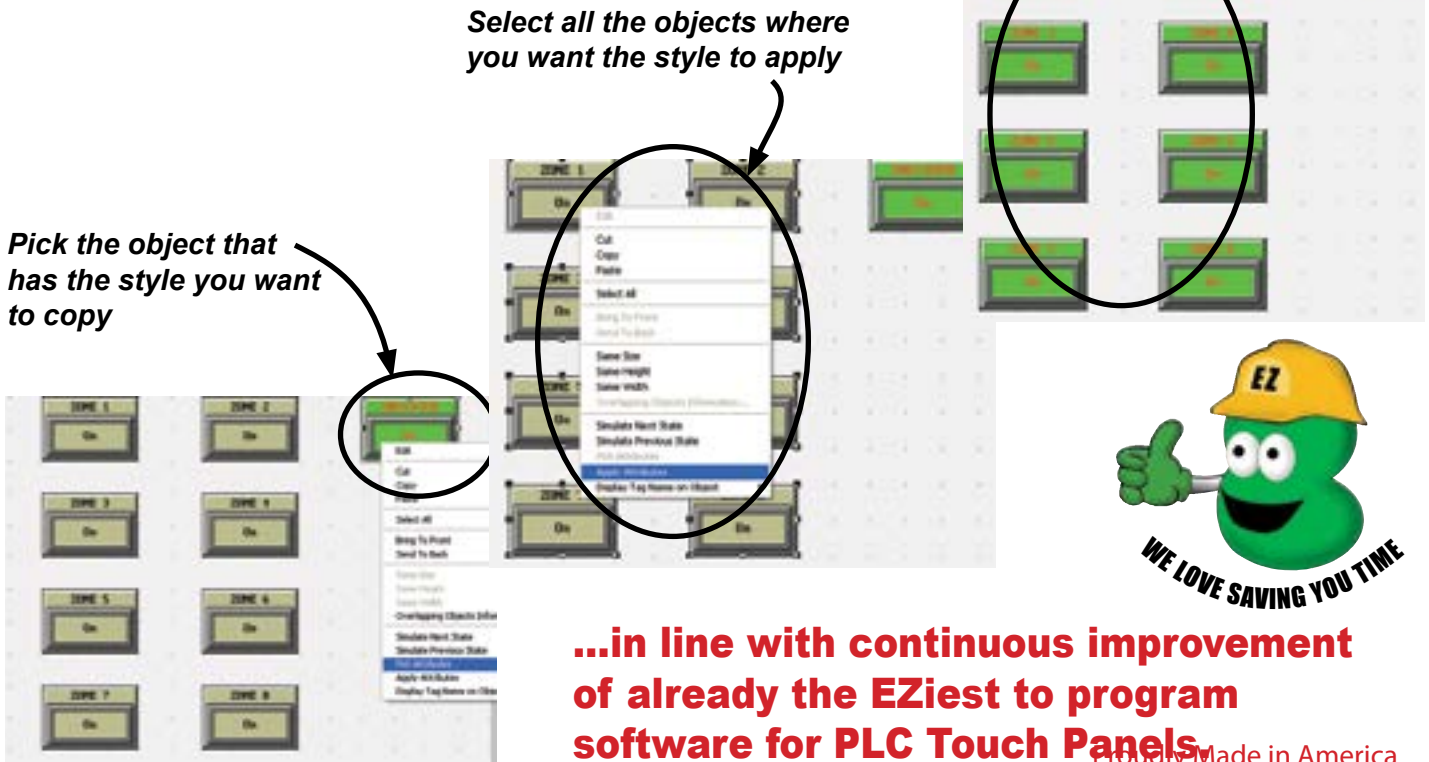

Pick the object that has the style you want to copy

Select all the objects where you want the style to apply



...in line with continuous improvement of already the EZiest to program software for PLC Touch Panels.

Proudly Made in America

EZiest to Use Programming Software

In Continual State of Improvement

Project Simulation

1 What is Project Simulation?

This feature allows you to simulate, interact, navigate and debug an entire project right on your PC, before you transfer it to the panel. It ensures that your project looks and operates exactly the same way you intended.

2 How to Interact with the Objects?

On the PC you will have to click on the objects, as you do touch/press them on the panel.

3 How to test the functionality of the Objects?

By changing the tag values of the objects and view their responses. Tag values can be changed either in the tag list or in the separate dialog boxes by right-clicking individual objects.

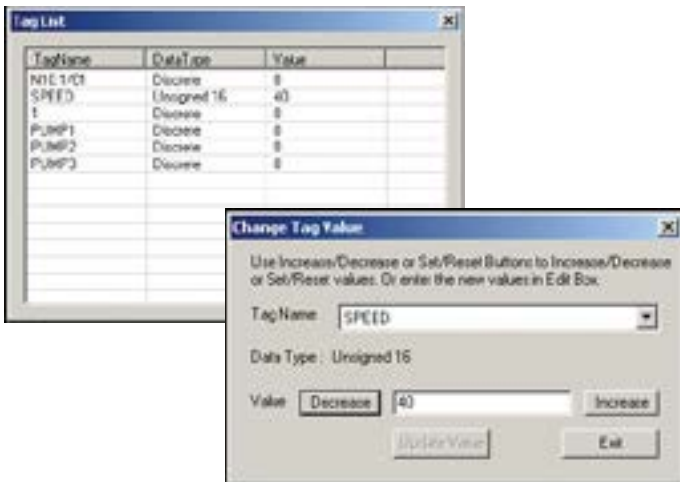

4 What is the purpose of Screen Capture?

This is an option to take the screen shots of the simulator screens and save them for further references. Basically, screen shots give you an idea of how the panel screens will look like.

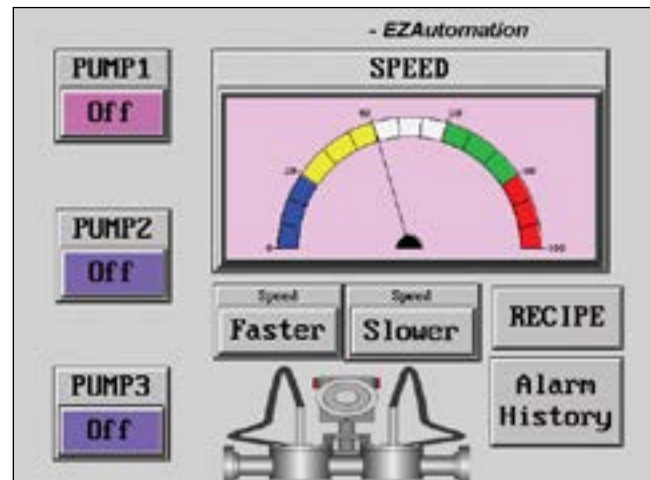

Distortion Free Sizing of Objects

The EZTouch Programming Software has a patent pending feature that saves the programmer from having to size a bitmap in another photo editing software, and then bring it onto the screen. You can size an object whichever way you want it within the EZTouch Programming Software itself. It saves you the headache of going back and forth between two software programs.

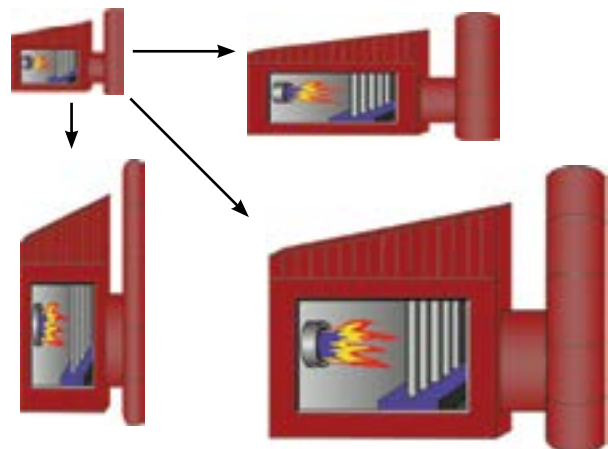

Proudly Made in America

EZTouch Programming Software

Advanced Bitmap Objects

Multi-state Bitmap Object

This object displays images within a given frame on the EZTouch® HMI. The object displays one image at a time based upon the bit that is on or the value of a tag. The maximum number of images is limited only by memory size. Our bitmaps use significantly lower memory because of our vector graphics.

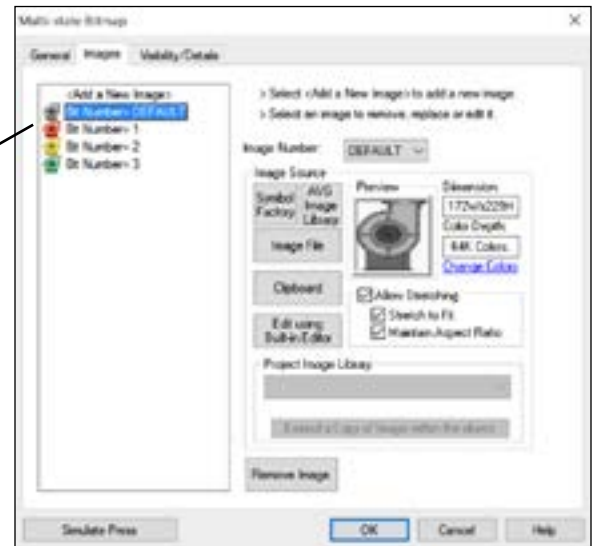
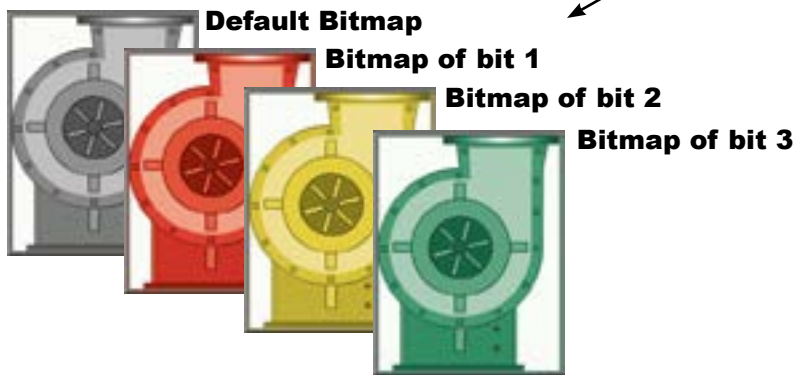

Multi-state Indicator Object

The Multi-state Indicator Object has been created to display preprogrammed messages within a frame on the EZTouch® HMI. Each object has its own message storage and does not need an external database. 256 messages can be displayed based upon the value of a bit or of a tag.

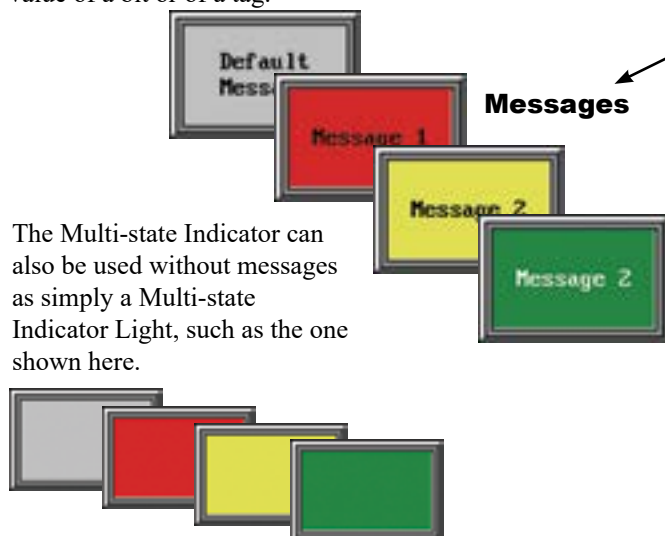

The Multi-state Indicator can also be used without messages as simply a Multi-state Indicator Light, such as the one shown here.

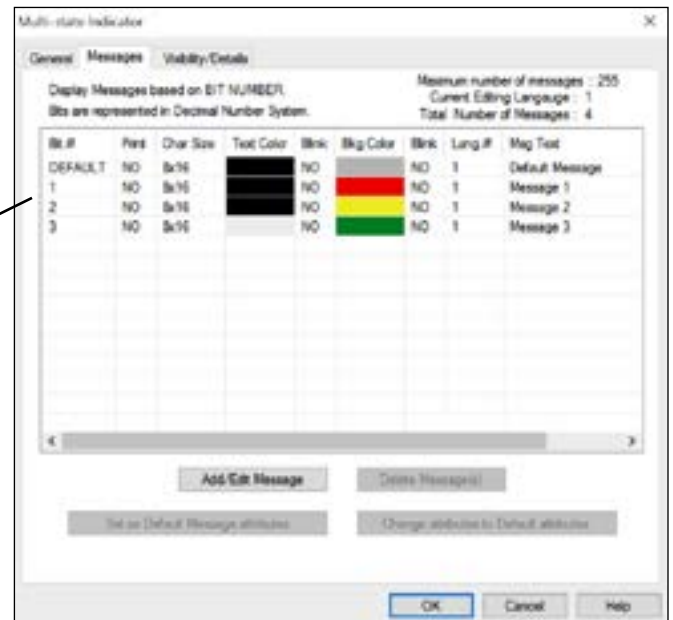

EZiest to Use Programming Software

More Convenience Features

Increment/Decrement Value Object

This object allows you to program a button that allows addition or subtraction of a preprogrammed value read from one tag and written to another as shown to the right.

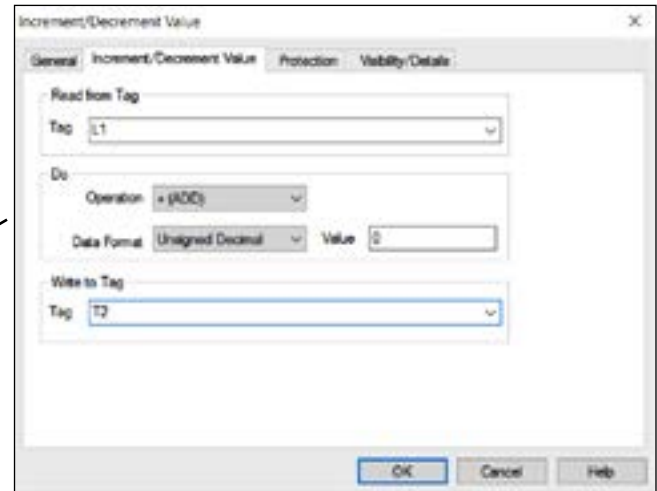
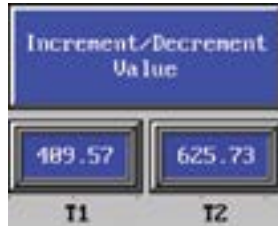

EZ Touch HMI

Instant Mouseover View of Colors

Instantly see your color selections as you mouseover the color palette

It is a simple but great idea not found in many of the leading HMIs in the market. When you mouseover different colors, you will simultaneously see it on the target object. No guess work! It speeds up project development. Coupled with our instant transfer (on-line programming) from PC to the Touchpanel, you create and enjoy your graphics with ease.

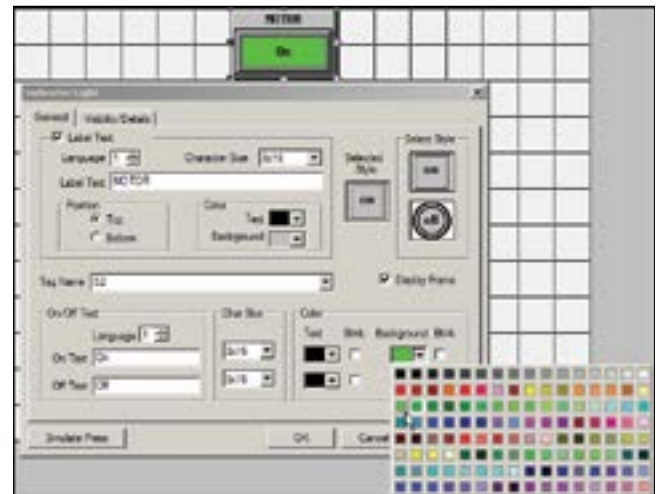

Screen Thumbnail View

Convenience to Speed up your Large Project Development Time

EZTouch Programming Software's Screen Thumbnail View is a unique and time saving feature for the convenience of programmers to avoid searching for one screen when there are more than 100 screen's in the software. On the right side of the Project tree we can find a screen thumbnail view which helps us to search the screen in minutes reducing the large project development time.



Proudly made in America

EZDac Data Acquisition Software

Log Data For Any PLC Tag

Available on RS232 Serial Port as well as Ethernet

What is EZDac?

EZDac is a data acquisition utility designed to collect and save tag data from one or more (connected and running) EZTouch Panels. The EZDac software allows the user to easily store and transfer data that is in the HMI (stored on USB or micro SD) to a network or PC

Innovate'n'Save™

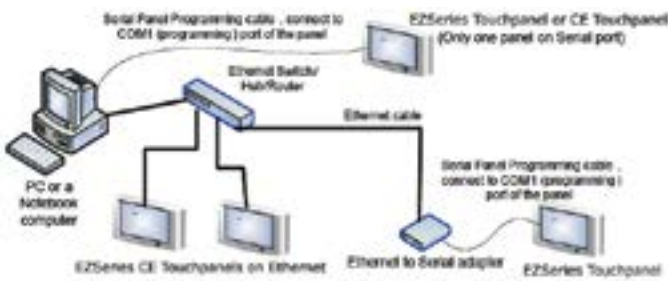

What kind of communication medium is required?

EZDac works on both **Ethernet** as well as **Serial** communication medium.

How does it work?

- 1 Run the EZDac application on a PC to create a Data Acquisition Schedule file.
- 2 Specify the tags and a schedule for each tag for data acquisition.
- 3 The Schedule can be set either on the basis of time or an event.



- 5 Once the Schedule file is created, the application can start collecting and storing acquired data.

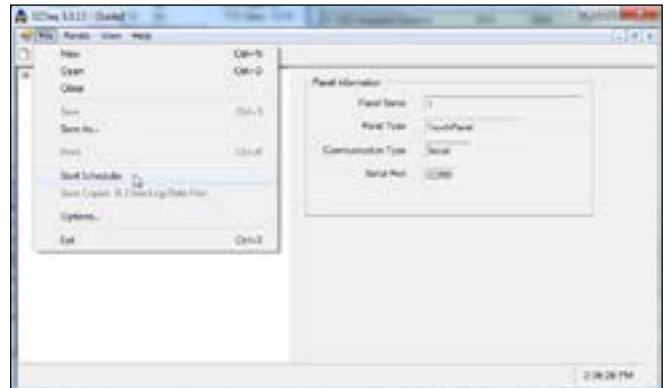

- 4 While creating the Data Acquisition Schedule file, Panel (from which data has to be collected) must be connected to the PC.



How to view data?

Data files are organized in a convenient user selectable format (tab delimited or CSV) and can viewed in excel or any text editor.

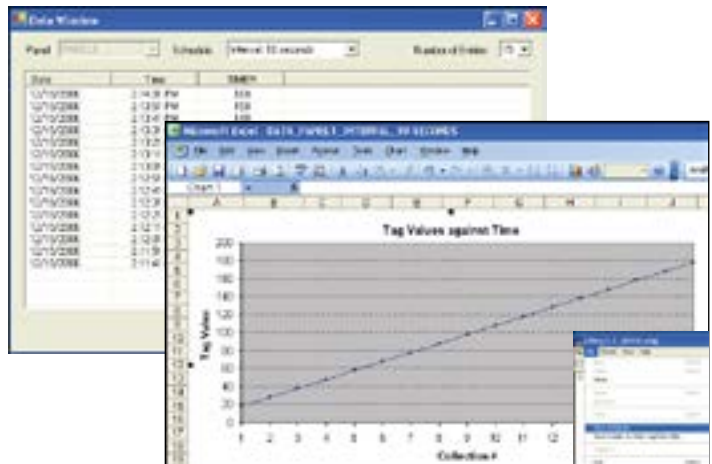

Made in America

AVG File Manager for EZ3 Series

Data Logging Transfer Utility

AVG File Manager is a data acquisition utility designed to collect and save tag data from one or more (connected and running) EZ3 HMIs. The utility allows the user to take the data stored on the HMI (stored on either USB or microSD) and transfer the data over Ethernet to a designated folder on the Network. It essentially acts as a paperless chart-recorder. Data is transferred instantaneously as soon as the Move/Copy button is initiated.

FREE
Data Log
Utility

RMC File Manager Download Utility

1 Click on the panel list manager to add/delete panels

2 Select Panel to connect

3 Select the datalog csv file you want to transfer to your computer

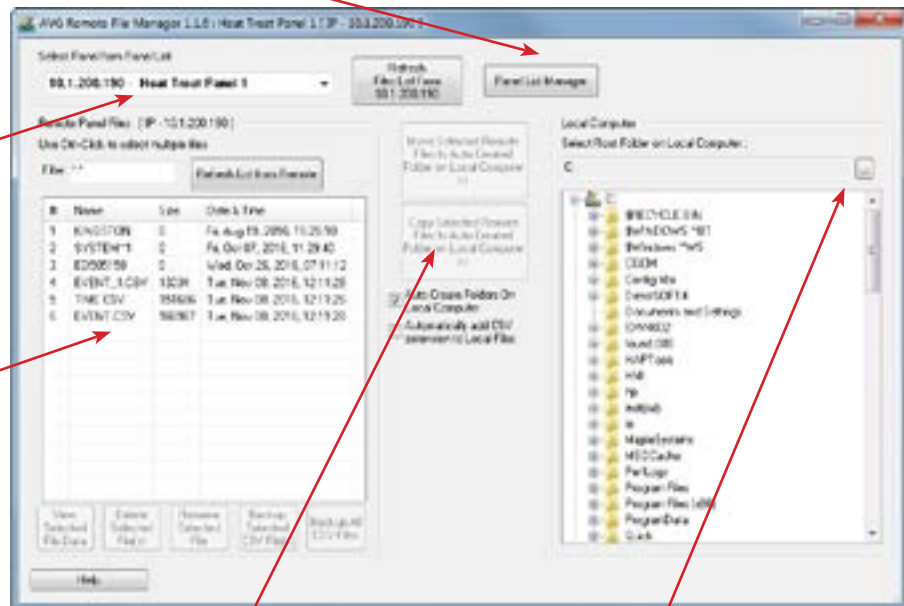

5 Select move or copy the csv file

4 Select the local folder on your computer to store the csv file

Free to
File Manager
Download

Innovate'n'Save™

Proudly Made in America



EZTouch Programming Software

Database Management

Import / Export of Tag Database

EZ Series programming software allows both import and export of tag database from and to an Excel sheet. This saves a tremendous amount of time when developing PLC software using the same tag names.

The enhanced ability of Import/Exporting the tag database, Highlighting the unused tags, and Instant Syntax checking makes it extremely convenient for the programmer to manage his/her project.

High-light Unused Tags

The Tags in the EZ Software can easily be sorted by name, by type and by PLC address. On top of that you can high-light unused tags in yellow to make it EZ on the programmer to manage his/her project.

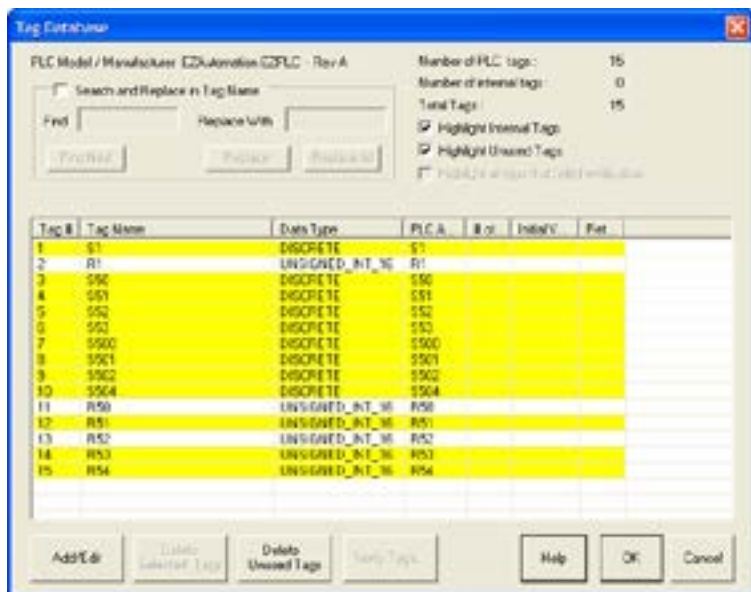
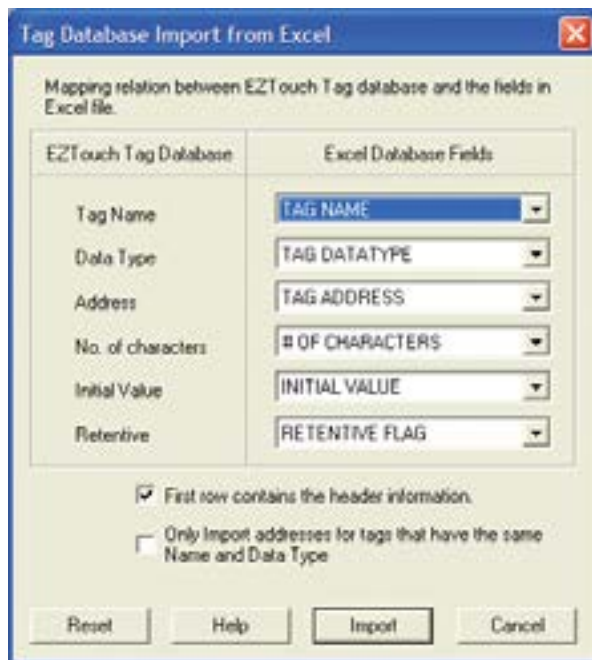

Instant Syntax Checking

The EZ Series Touchpanel software is unique in that, it checks the address syntax of all the PLCs and PLC Networks supported, before the address is allowed to be entered. This feature saves a tremendous amount of time in implementing an HMI PLC Project. **You find your errors at the time of making the error, not when you are finished and saving or downloading the project.**

Innovate'n'Save™

...in line with continuous improvement of already the EZiest to program software for PLC Touch Panels.

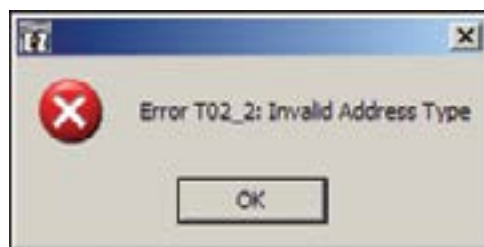

Proudly Made in America

EZTouch® HMI Objects

Simple yet Powerful Objects that Look Great... Now that's EZ!

This and the following pages describe the majority of the objects in the EZTouch editor. For detailed description of more advanced recently introduced objects, refer to pages listed.

On-Screen Recipe Edit - Page. 5-41

Real-time Animation Objects - Page. 5-42

Unicode Objects - Page. 5-43

Advanced Alarm Management - Page. 5-44

Pushbutton

Allows you to write to a tag, and offers 5 types of button states: Momentary ON/OFF, Set ON/OFF and toggle.



Indicator Pushbutton

Combines a regular pushbutton with an indicator light, allowing you to write to one bit and read from a second location, determining what the button displays.



Radio Pushbutton



One button can be on at any given time. When a button is pressed it releases any button that may be on, and becomes the active button.

Switch

Simulate mechanical switches of the same type, e.g.; Throw, selector, slide, toggle, etc.



Step Switch

Simulates a mechanical step switch, allowing simultaneous monitoring & control of up to 4 different bits.



Tri-State Switch



This object controls two bits at a time from 2 different tags. If the first button is pressed, both the bits are off. If the second button is pressed, the first bit on and second bit is off. If third button is pressed, the first bit is off and the second bit is on.

Numeric Entry

Write a value to a PLC register. A numeric keypad will pop up when this object is pressed on the screen.



Recipe

Download up to 20 preset or variable PLC registers per recipe in the EZTouch® HMI. This object can also be used to set values in PLC registers to change a process all together!

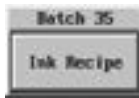

Thumbwheel

Simulating a mechanical thumbwheel, this pop-up thumbwheel allows operators to scroll each digit up or down, then "ENT" to download entry to the PLC.



Indicator Light

Monitor and display the state of a bit. For example, the indicator light could display the status of a bit linked to a push button.



Numeric Display

Display a numeric tag value on the screen within a frame.



Analog Clock



Digital Clock



Two options for displaying time.

Meter

The meter object is an excellent graphical representation of an analog gauge, such as a speedometer or thermometer. Custom design the color bars for alarm zones, select the number of divisions to be displayed and the values of the meter.



Bar Graph

Allows you to monitor and display a tag value in a bar graph form on the screen. The bar graph can be displayed in various formats and can be programmed to read from top to bottom, left to right, right to left, etc.



Line Graph

Monitor specific tags and display the value of these data tags as they change over time. You can custom design the legend for X and Y axis and assign labels to major "tic" marks on a chart. This object also has VCR type forward/backward controls to view historical data.

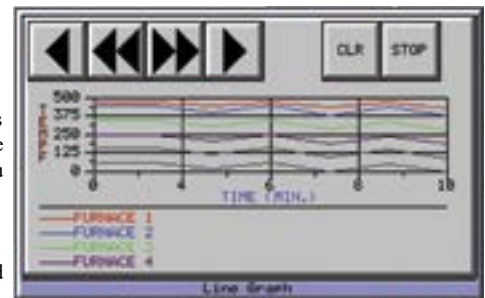

PID Faceplate

Use our PID faceplate for PLC systems capable of PID loops. PID faceplate allows you to display values for three PID loop controlled parameters in the form of bar graphs. These graphs then provide valuable and timely process information. This object also monitors two discrete bits: Mode Bit and Alarm Bit, telling the operator whether the process is in Auto or Manual mode, and if any alarm for the process is active or not.

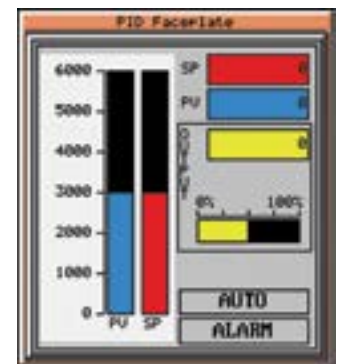

Screen Change

Use this object to jump or change to (display) another screen.

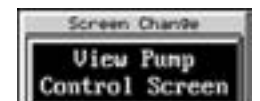

Produced in America

EZTouch® HMI Objects

Alarm History

Use our pre-built Alarm History button to show Alarm Count and Alarm History with one touch of a button. Alarm History displays all the alarms triggered sequentially with the most recent one right on the top, whereas Alarm Count displays the exact number of times a certain alarm has been triggered. Use this great preventive maintenance tool to replace any components that need to be changed. Any time an alarm is highlighted and selected, it will show you all the details that you'll ever need to know including the time it was triggered, the time it was cleared, date stamp, upper and lower limits along with the limit that tripped an alarm.



Multi-state Indicator

Display preprogrammed messages within a frame. Each object has its own message storage and does not need an external message database. Up to 256 messages can be stored, and the one message that is displayed is based upon the value of a bit or a tag. Messages can also embed data variables. In addition, this object can be used as an indicator light, displaying only colors without messages.

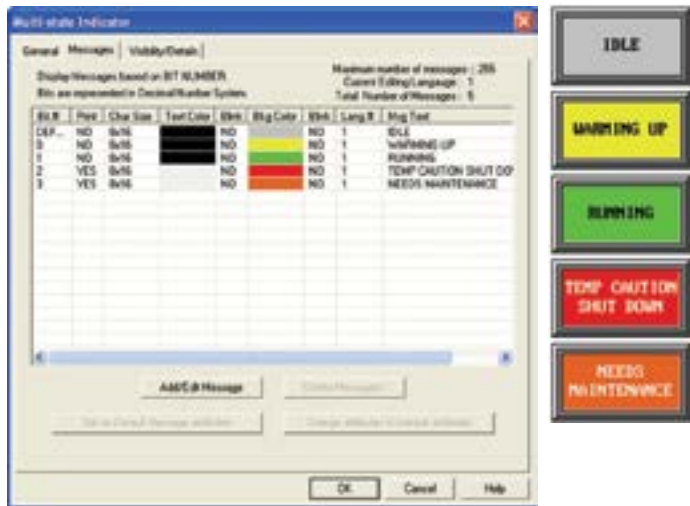

Increment/Decrement Value

This button allows addition or subtraction from a value using two predefined tags and a preprogrammed value. Once pressed, this object will read the value from the first tag, add/subtract the value defined, and write the new value to the second tag.



Static Text

Place text anywhere on the screen to provide information, screen description, etc. As with any other object, you can fully customize the colors and size, choose whether to display a frame or not, and whether or not you want its background to be transparent.



Trigger Text

This object monitors a bit to display different text strings for "ON" and "OFF" conditions. This would be used in applications where you want to provide a message or a description of the process or condition.



Lookup Text

Similar to the Multi-state indicator object, create a Lookup Text object to display pre-programmed messages within a frame on the screen. The difference is these messages are stored in the "Message Database" which acts as a global database for any lookup text object to reference throughout the project. A value corresponding to the tag name is the message number that will be displayed inside the frame. Messages are numbered from 1 to 999, so if the value corresponding to the tag name is 10 for example, the message number 10 will be displayed.



Dynamic Text

The Dynamic Text object will allow you to display the characters from ASCII values stored in a Tag. The tag will read a block of registers in the PLC. Each 16-bit register in the PLC can contain 2 ASCII characters. The maximum number of PLC registers in the block is 20 (a maximum of 40 ASCII characters). This object is typically used for displaying part numbers, VIN numbers, or production numbers. Dynamic Text is triggered by a bit Tag in the PLC. You choose whether the Text is triggered by the bit when it is in the ON state or the OFF state. The Dynamic Text object will then display a text string that is programmed in the PLC.



Text Entry

The Text Entry object, when pressed on the panel, brings up a character entry (alphanumeric) keypad. This allows the operator to enter text up to 40 characters to send to a tag assigned to an address in a PLC.



It has many uses, some of which may be: to send part numbers or production numbers to a PLC, or to send a message to a PLC that will, in turn, route it to one or more plant floor message display(s), such as EZMarquee.





EZTouch® HMI Objects

Adjust Contrast

Use the Adjust Contrast object to place a button on the EZTouch® HMI screen that gives you access to the panel's adjust contrast feature. Use the UP and DOWN arrows that appear on the bottom to adjust the screen contrast.



Increment/Decrement Hour

Place an object on the screen that allows you to adjust the hour (up or down) of the internal Real-time clock.



Activate Screen Saver

Place a button on the screen that enables you to activate the panel screen saver, to lengthen the longevity of the panel.

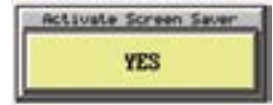

Select Language

This object allows the operator to change the language by pressing the button on the panel. Text that has been programmed for that language will convert to the language that the operator selects.



EZTouch® Editor allows you to create Dynamic Bitmaps, Multi-state Bitmaps, Button Bitmaps, and Static Bitmap Objects in a breeze.

There is a built in library of 4,000 objects available for you to copy and paste directly to a project screen and use them in any arrangement or position them just the way you like.



EZ Touch HMI

Static Bitmap

A static bitmap lets you simply display a bitmap which can be resized within the editor and stays static on a screen, e.g. a company logo.

All bitmaps can be imported, copied from the clipboard, or pulled in from the symbol factory (as shown to the right) and the EZTouch® HMI supports the following formats: .bmp, .wmf, .emf, .gif, .jpeg, .jpg, and .ico.



The Symbol Factory's 4,000+ symbols are available to all bitmap objects in the EZTouch Editor's software.

Sizing Bitmap Objects is EZ!

The EZTouch Editor has a patent pending feature that saves the programmer from having to size a bitmap in another photo editing software, and then bring it onto the screen. You can size an object whichever way you want it within the EZTouch® HMI Software itself. It saves you the headache of going back and forth between two software programs.

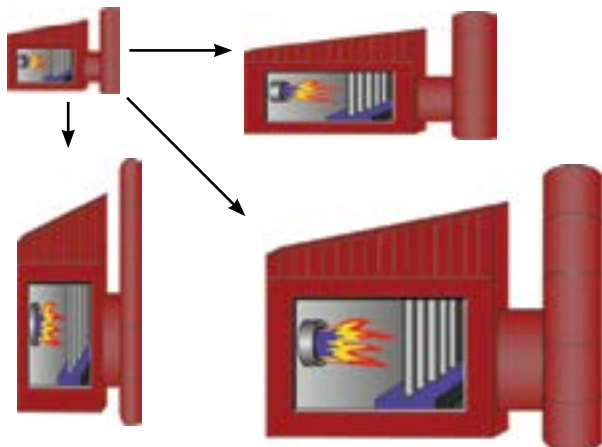

de in America

EZTouch® HMI Objects

Bitmap Button

The Bitmap Button object allows the use of bitmaps for the ON/OFF states, instead of text or colors. For example, you could place a throw switch and static text labeling on/off states. When the operator presses the switch, the bitmap is replaced with the OFF state bitmap, showing the switch down. This is a simple toggle between ON/OFF states. You can also have buttons stay ON or turn OFF only when the operator is pressing the button, as shown farther right. There is even one more option in which a button, once pressed, can only be turned ON or OFF by a non-HMI source, like a PLC.



Dynamic Bitmap

A Dynamic Bitmap object, while not an interactive button, can show a dynamic visual representation of a process. Simply select a bitmap to represent the process running and another to represent the process not running, as the ON/OFF states of the bitmap.

For example, if your process uses a pump, and you want a visual representation of when the pump is on or off, then select the dynamic bitmap object. Click the symbol factory button from the On Bitmap section of the dialog box to access the symbol factory. After selecting the pumps category from the list on the bottom left and then the desired pump, click Options. This gives you the ability to change the object's shading, color, orientation, etc. When finished and out of the Symbol Options box, click Copy, which copies the bitmap to the clipboard. Then click Copy From Clipboard. This places the symbol into the object's On Bitmap state. Repeat these steps for the Off Bitmap, and you are done!

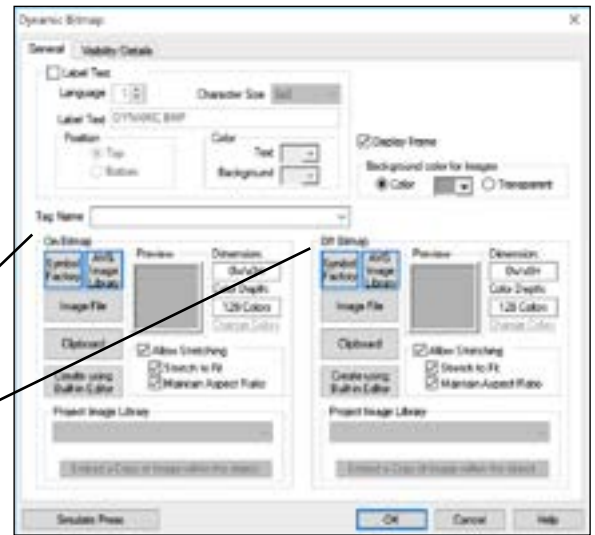
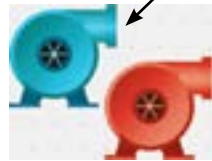
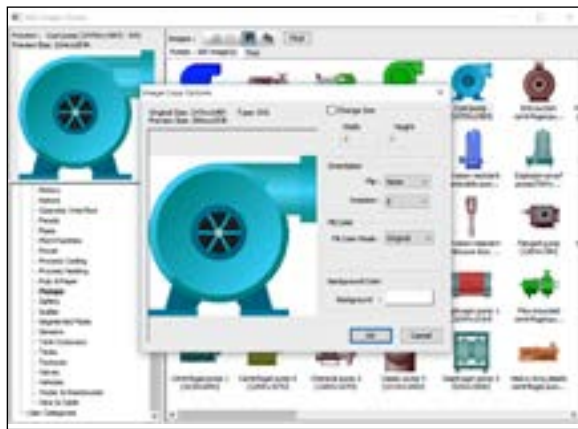

Multi-state Bitmap

Similar to the Multi-state Indicator, this object displays predefined bitmaps instead of messages. Choose up to 16 different bitmaps to represent various conditions of a process. The bitmap shown is based on the value of a bit in a word or a word address. The example below shows how an operator would know the condition of the machine based on the colored bitmap which is displayed.

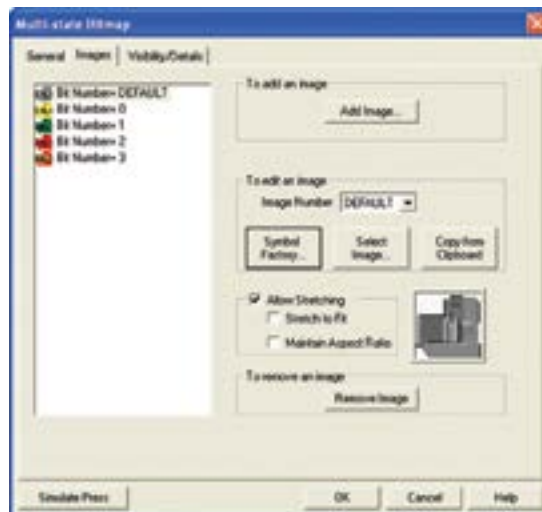

Update Project Screens Over Internet or Email

NO Programming Software or Knowledge of HMI Programming Required

Where OEM Packager makes sense

EZ OEM Packager is a unique utility which allows OEMs and System Integrators to Email the Enduser's HMI program over the internet. The Enduser will not need to have the EZPanelEdit Programming Software. It also protects the OEM/SI from having the Enduser have access to the development HMI program.

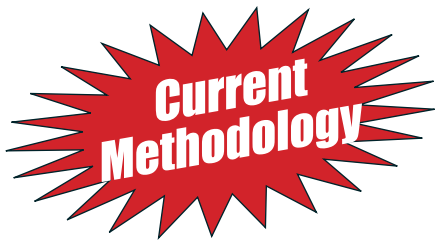

OEM/SIs are typically forced to snail-mail Touchpanel Upgrades/Updates using Compact Flash cards or USB Drives (assuming end user does not have a copy of HMI programming software). Sending compact flash cards through regular mail is a time consuming process and can take several days before the end user receives the update. For International customers this could mean delay of weeks if not more!



3



4



OEM/SI Utility (EZPackager) creates updates in the form of Zip files from the programming software. This update (zip file) can be e-mailed to the end user within minutes. The end user simply extracts the zip file and runs the updating utility (EZPanelUpdater.exe) to complete the update. HMI programming software is not required by the end user for this update.

1



2



3



NO SOFTWARE NEEDED



rica

Innovate'n'Save™

EZTouch® EZ 3 Series™
ENHANCED

EZTouch EZ3 "Enhanced" series models which are direct drop in replacements for all EZ3 HMIs

The Work Horse Fully Loaded, Fully American 2 Serial, Ethernet, 2 USB, micro SD Full Feature Unit

**23 Exceptionally Innovative Features. Lasts twice as long:
NEMA 4X, 400 nits, 75KHrs@55°C**

List of Innovative Features

1. 400 nits, 75K hrs. @ 55°C
2. Patented HMI on-line edit, No downtime
3. EZ mini Wifi to program/edit HMI without cable
4. On-Screen Recipe Edit.
5. Dual PLC Drivers with automatic tag conversion.
6. Only HMI that can still talk to AB's DH+
7. "C level" scripting and logic expressions.
8. EZiest Program Software, design time in hrs not days.
9. Upload HMI program from USB without software/cable
10. Fastest touch response time of any HMI.
11. Best looking objects and animation with 65K colors.
12. Every model Fully Loaded, No "R" Reduced Features models. and the list goes on...

Latest Innovation



Tiny EZminiWifi to program/edit HMI without cable



Available EZ3 Enhanced models
6" HMI | 7" HMI | 8" HMI | 10" HMI
12" HMI | 15" HMI

Innovative Unique Features

- 400 NITs, 75K Hrs @ 55°C
- Patented HMI on-line edit, No downtime
- Tiny EZminiWifi installed on the HMI allows Laptop to program HMI from 400 ft. away.
- Only HMI that can still talk to AB's DH+ (except 7")
- EZTouch EZ3 HMIs have real time access to process data stored inside the HMI or the USB drive and the micro SD using AVG File Manager utility.
- EZTouch EZ3 HMIs in a plant or multiple plants have the capacity to be monitored using EZPlantview software.
- Best looking objects and animation with 65K colors.
- Most Rugged 0.090" thick anti-glare touch screen.
- Unicode for multiple languages.
- Easiest Programming Software, design time in hrs not days.
- Full Project simulation on your PC.
- "C level" scripting and logic expressions.
- Data-logging, Recipes, Emails, USBs. Free Chart recorder.
- Most advanced Alarm management and logging.
- On-Screen Recipe Edit.
- Every model Fully Loaded, No "R" Reduced Features models.
- Remote Monitoring and Control, Smart phones & Ethernet.
- Communicate to all PLCs, including DH+ & Ethernet IP.
- Dual PLC Drivers with automatic tag conversion.
- Mfr. cost reduction & IP protection for qualified customers.
- Unique Visibility tag for best screen space utilization.
- Pass-through programming for all PLCs.

EZ3 Features & Benefits

Patented HMI on-line edit, No downtime. Watch it in action.

All HMIs except for EZtouch, require the machine or process to be shut down to make a change in the HMI program. While a new program is being uploaded to the HMI, it is non-functional and hence the machine can't be allowed to operate during this time. Every time the HMI program is edited, there is machine down time of typically an hour. All EZTouch series HMIs have a patented on-line edit exceptionally innovative feature that allows the HMI program to be edited without the machine missing a beat.

In a recent study, more than 2/3rds of control engineers stated that after the HMI is installed in a machine or process, the plant user, system integrator or OEM requests some change in the screen design at least 10 times in the first 90 days following installation. Even if you were able to make the change in half-an-hour, machine/process will be down by 0.5 hr. each time change is made. Taking downtime at even a low cost of \$1000/hr., the patented unique HMI online feature in all EZTouch HMIs, saves you at least \$5000 in just first 3 months of operation.

400 NITs, 75K Hrs @ 55°C

When evaluating HMIs for you Machine or Application you should look at the overall cost of ownership. EZTouch displays all have LED backlight which is lot more durable in fact it is rated at 75K Hrs while operating at 55°C as compared to most of our competition's 50k Hrs at 25°C. In addition, EZTouch displays have a higher brightness of 400 NITs as compared to 230 to 250 NITs from others. In short, EZTouch HMIs last twice as long.

Tiny EZminiWifi installed on the HMI allows Laptop to program HMI from 50 ft. away.

This tiny little module that plugs into one of the serial ports in the HMI (we recommend installing on every HMI) allows a programmer to connect his/her laptop to the HMI without a cable. So many times, it is not so easy to reach the Operator console to connect the programming cable to the HMI. Combination of our patented On-Line Edit feature and EZminiWifi becomes an exceptionally innovative solution to making changes on HMI screens without having to open up the control cabinet and connect the Programming cable.

Only HMI that can still talk to AB's DH+

Allen Bradley/Rockwell is no longer supporting its DH+ protocol originated in 1980's. Whereas there are over one million nodes in manufacturing plants all over the world on PLC2, PLC5, SLC 500, Control Logix, Compact Logix and Micro Logix PLCs, there is no other HMI on the market that still supports the DH+ protocol. It is because of EZTouch HMIs that these plants do not have to change their networks to Ethernet I/P, saving them hundreds of thousands of dollars.**Note: DH+ is available in all EZ3 models except 7"

Model Selection

EZ3 is available in 6", 7", 8", 10" and 15" displays. Please note that 7" model does not have DH+ capability. Also 15" model is EZ-T15C-E even though it belongs to EZ3 family for all the rest of the features.

Dual PLC Drivers with automatic tag conversion.

All EZTouch HMIs now have the capability to simultaneously talk to two PLC networks. For example, Ethernet I/P on one side and Modbus RTU on the other side. Tags are automatically converted. This allows the two networks to communicate to each other through EZTouch.

Best looking objects and animation with 65K colors.

EZTouch HMIs have the best looking objects simulating real life panel actuators and indicators. And the animation of process is great. All EZTouch HMIs except the EZTouch Original now have 65K colors.

EZ Sunlight readable models for 6" & 10" models.

EZTouch HMIs have a 6" 800 NIT and a 10" 1000 NIT Sunlight readable model that allows the screen to be viewed and operated in bright sun light such as the deck of an oil rig or a naval vessel. All other features remain the same as in respective models.

Most Rugged 0.090" thick anti-glare touch screen.

All EZTouch HMIs except the 12" model have an extremely rugged customized touch screen that is 0.090" thick as compared to paper thin touch screens used in our competitor's products, increasing the durability of the EZTouch touch screen.

Mfr. cost reduction & IP protection for qualified customers.

EZAutomation has an extremely innovative service for its qualified customers. Many OEMs and System Integrators want to protect their intellectual property incorporated into their HMI. Since you are buying directly from our factory, for a certain minimum volume per month and a service fee, we can load your program and do a brief quality test of the HMI prior to shipping. This service cuts down your manufacturing cost of programming each unit prior to installation on the machine. This includes giving your product a unique part number of your choice to protect your investment in the purchase of your HMI by any third party. Call the Factory to find out the cost of this service per unit and other details.

Unicode for multiple languages.

All EZTouch HMIs have a Unicode feature for multiple languages, that is each Object can be displayed in different languages. This allows every operator of the HMI to be able to communicate to it in the language of his or her choice.

Easiest Programming Software, design time in hrs not days.

There is a reason why our company is called EZAutomation and our HMI is called EZTouch. We make it so easy to learn our programming language that no user, hundreds of thousands so far, thank you, ever had to attend any class to learn the programming. Most of our competitor's products, like from Rockwell, Siemens, Mitsubishi, Unitronics, Schneider, Maple and others require a 3-5 day class to learn how to program their products. Our programming language is so intuitive and so simple that the design time for any screen and the entire project is reduced to hours instead of days.

Full Project simulation on your PC.

EZTouch programming software allows you to preview and test your entire project by our Project simulation feature on your PC itself before loading it up in your EZTouch. It's a great time saver for programmers.

"C level" scripting and logic expressions.

This unique feature in all EZTouch products off loads a very substantial burden on the PLC and reduces PLC scan time, number of rungs, and size of memory,

as these calculations can be done essentially off-line in HMI.

Data-logging, Recipes, Emails, USBs. Free Chart recorder.

EZTouch EZ3 can store HMI/PLC data on EZ3s USB or micro SD card and remotely retrieve this data real-time over Internet using AVG File Manager. The USB drive or the micro SD serves as a free chart recorder saving the cost of an external chart recorder costing hundreds of thousands of dollars.

Most advanced Alarm management and logging.

*New Feature: EZTouch now provides an Alarm database, Alarm preview, Alarm history, Alarm count, Alarm protection and a special feature to send Alarm directly to EZMarquee. It also allows for the EZtouch HMI to email or text alarm messages.

Plantview Capability

All EZTouch EZ3 HMIs in a plant or multiple plants, have the capability of getting monitored by using EZPlantview software allowing all critical parameters to be collected and displayed in the individual EZ3 HMI which can be viewed on one or multiple large screens in a control room.

On-Screen Recipe Edit.

All EZTouch HMIs feature an on-screen recipe edit where you can edit the recipe on the HMI itself without needing to connect to a laptop with programming software.

Every model Fully Loaded, No "R" Reduced Features models.

All of the EZ3 EZTouch models are fully loaded and compete very well with even the Reduced Feature models from Automationdirect. For example our 7" EZ3 model has 2 Serial Ports, Ethernet, Micro SD, USB programming port, USB data storage port and all the software features at \$429 as compared to the \$472 of Automationdirect for their Reduced Feature "R" model and of course their Full feature model at \$548

Remote Monitoring and Control, Smart phones & Ethernet.

All EZTouch HMIs have a remote monitoring and control feature where you can monitor and control the functionality of an HMI remotely via a Smart phone with iOS or Android OS. RMC can also be

done over Ethernet connection in all EZTouch HMIs.

Communicate to all PLCs, including DH+ & Ethernet IP.

EZTouch HMIs have the highest connectivity to a PLC with serial protocols, Ethernet protocols such as Ethernet IP, Modbus TCP/IP, GE SRTP, Siemens ISO, K-sequence and of course the EZ Protocol, as well as DH+. Serial protocols cover 98+% of all PLCs in the market. **Note: DH+ is available in all EZ3 models except 7"

Lowest cost, powerful Soft HMI for any Windows based PC.

EZAutomation also offers a phenomenal soft HMI that features all the great objects and connectivity of EZTouch HMIs. It is extremely innovative in that it does not have any limitation on number of tags or number of screens. Data logging is all local in the PC it is installed in. If the PC has a serial port,

it has connectivity to all PLCs. If the PC has only Ethernet, all Ethernet protocols are available for communication.

Unique Visibility tag for best screen space utilization.

EZTouch HMIs have an extremely innovative Visibility tag on all objects. Object appears on the screen only if the visibility tag is true. Along with EZTouch's feature of overlapping objects, visibility tag is a great space saver on the screen.

Pass-through programming for all PLCs.

All EZTouch HMIs allow pass-through programming of any device connected to the HMI, whether it is a PLC, PAC or a Drive. PLC Programming software of any make, for example Rockwell can pass through the same programming port as the EZTouch programming software making it very convenient to program the whole control system through just one port/connection.

Patented HMI on-line edit, No Machine Shutdown, No downtime!

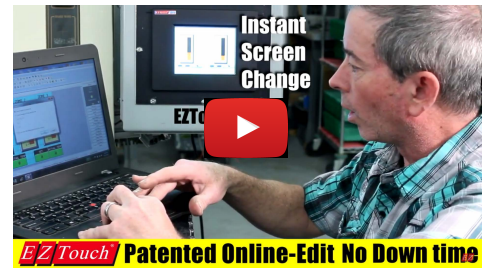

You wouldn't buy a PLC today if it didn't have On-Line Edit...

...So why should you have to buy a Touch Panel without On-Line Programming?

Only the EZTouch® has On-Line Programming

1. After a machine upgrade including a new PLC and Operator Interface, our System Integrator asked the Machine Operator what he would like to see better yet. The Operator said the new "computer" was great with all the colors but he missed the old pressure gauge.
2. Our System Integrator immediately pulled out his notebook computer, hooked it up to the Touch panel,
3. And then, right in front of the operator's eyes, moved the other objects on the screen and put an Analog Meter exactly to the operator's color taste, without ever having to shut down the machine.
4. All this took less than 2 minutes. Operator: "Now that is nice!" Let's get these on all the machines."

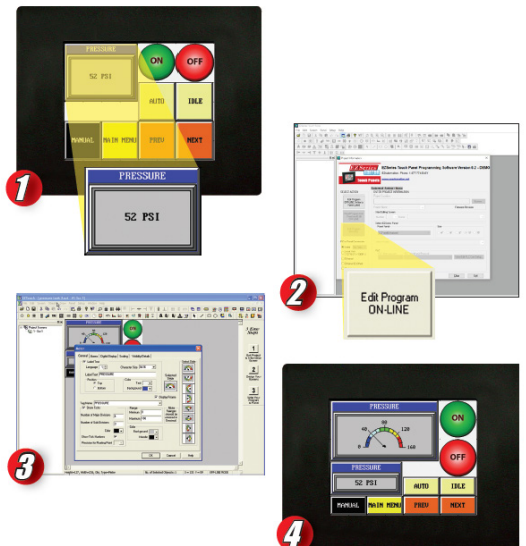

PLC Communications and Drivers

The EZSeries HMI Touchpanels communicate to more PLCs and Networks than any other HMI. Allen-Bradley panels talk to mostly AB PLCs, Siemens panels talk to their PLCs, Mitsubishi HMIs communicate mostly to their PLCs and so on.

A vast majority of North American Plants still have AB's Data Highway Plus (DH+) networks in place.

Industrial Ethernet is fast becoming the hardware communication platform for an increasing number of plants all over the world. But Ethernet without the proper supporting protocol (software driver) is like having a great vehicle without tires. Not so with EZAutomation, our EZTouch EZ3 Series HMIs can communicate to all major ethernet networks including but not limited to:

- Allen-Bradley Ethernet I/P to Controllogix and Compactlogix
- DF1 protocol over Ethernet for Micrologix & SLC 500 series PLC's
- Siemens Ethernet ISO over TCP/IP
- Modbus TCP/IP
- SRTP for GE networks

EZTouch EZ3 HMI Supported Drivers:

Allen Bradley:

- A-B DF1 Half and Full Duplex (PLC-5, SLC500, Micrologix 1000, 1200 and 1500)
- DH485/AIC/AIC+ for Micrologix 1000, 1200,1400, 1500,SLC 500, 5/01, 5/02, 5/03)
- A-B Micrologix 800 CIP Protocol
- A-B EtherNet/IP (MicroLogix 800, Control & Compact Logix)
- A-B DF1 over Ethernet (for Micrologix & SLC 500 PLCs)
- A-B Data Highway Plus (DH+) except 7" EZ3

Automation Direct:

- ADC K-Sequence (Direct Logic PLCs)
- DirectNET (Direct Logic PLCs)
- Do-More PLC (Serial & Ethernet)
- Modbus (Productivity 3000 PACs, Direct Logic PLCs, Click PLCs)
- ECOM Ethernet (Direct Logic PLCs)
- Entivity Think&Do (Modbus RTU and Modbus TCP/IP)
- Productivity Driver (Serial & Ethernet)

ABB: (COMLI Driver)

All Motion: (EZ Stepper)

Animatics: (Smart Motor)

Applied Motion: (SCL series)

Aromat: (Mewtocol)

AVG / EZAutomation:

- EZRack PLC (Serial)
- EZRack PLC TCP/IP
- EZPLC
- EZ Ethernet

Baldor: (Host Comms)

Bristol Babcock: BSAP Native (serial)

Control Techniques: Unidrive 2-wire, 4-wire (binary)

Control Technology Corp (CTC): CTC 2600, 2700 and 5100 (CTC Binary)

GE:

- GE Fanuc SNPX (90/30, 90/70)
- GE SRTP over Ethernet

IDEC: Computer Link

Keyence: (CV 5000)

Mitsubishi:

- FX Series CPU (Computer Link)

- FX-1N(C), 2N(C), 3(U) CPU
- Q Series PLCs
- A Series PLCs
- Melsec FX

Modicon / Schneider:

- Modbus RTU
- Modbus TCP/IP
- Uni-Telway

Omron: Host Link Adaptor

Texas Instruments (TI):

- TI 5x5 series, TI 505, TI 545-1102, TI 545-1104

Siemens:

- S7 (Serial:PPI)
- Siemens Ethernet ISO over TCP/IP
- S7-200, S7-300, S7-400, S7-1200 & S7-1500 series

Square D:

- Square D Symax – 300 Series CPU, 400 Series CPU

Yaskawa:

- Memobus Native Addressing
- Memo-bus RTU

Remote capability over PC, Tablet or Smart Phone (Apple iOS and Google Android)

EZ RMC™ Remote HMI for iOS and Android Devices



If you need assistance, be sure to visit the RMC Support page.

iPad Tablet EZ RMC™ Remote HMI is an application designed for your mobile devices on both iOS and Android platforms, for the monitoring and control of your EZTouch HMIs from EZAutomation.net. Enjoy direct access to your EZTouch HMI from anywhere at the tips of your fingers, on your phone or tablet. The EZ RMC™ Remote HMI is available on both the iTunes App Store as well as the Google Play store.

Features:

- Realtime View and Control of your EZTouch HMI panel
- “Pinch” style zoom for more in-depth view of your HMI project
- Save screenshots directly from the App
- Multiple user accounts can be configured for each panel project, with multiple levels of security, including either only Viewing ability, or both Viewing and Control
- Record your most used panels in your Favorites for quick access, and designate one HMI for direct access by default when the App is opened

Compatibility:





- iOS App works with all iOS devices (iPad, iPhone, iPod Touch) running iOS version 6 or later
- Android App works with devices running OS version 4.0.3 - Ice Cream Sandwich or later



Direct access to your EZTouch HMI is at your fingertips - from anywhere.

EZ3 Enhanced Series Selection Guide & Specifications

EZ3 Enhanced Series 6", 7", 8" and 10" Model Specifications

Part Number	EZ3-T6C-EE - \$599	EZ3-T7C-EE - \$549	EZ3-T8C-EE - \$1049	EZ3-T10C-EE - \$1349	EZ3-T12C-EE - \$1499
					
Specification	6" TFT Color Slim Bezel	7" Wide TFT Color Slim Bezel	8" TFT Color Slim Bezel	10" TFT Color Slim Bezel	12" TFT Color Slim Bezel
Enclosure	NEMA 4, 4X (indoor)				
Display Type	5.7" TFT (65K Colors)	7" TFT (65K Colors)	8" TFT (65K Colors)	10.4" TFT (65K Colors)	12" TFT (65K Colors)
Display View Area	4.65"x3.5" (118.1 x 88.9mm)	6.49"x3.9" (164.9 x 100mm)	6.05"x4.55" (153.7 x 115.8mm)	8.31"x6.22" (211.07 x 158mm)	9.68" x 7.26" (246 x 184.5 mm)
Screen Pixels	320x240	800 x 480	640 x 480	800 x 600	800 x 600
Brightness/Life	400 nits/75,000 hours (Even at extreme Operating Temp.)				300 nits/50K hrs@50°C
Backlight	White LED Strips				
Touch Screen	Analog Resistive Touch Screen				
Service Power	24 VDC (20-30 VDC Operating Range), 1.5A switching supply recommended				
Operating Temperature	0-55°C (32 - 131°F)				0-50°C (32 - 122°F)
Backlight Power	OFF	8 Watts @ 24 VDC			
	ON	15 Watts @ 24 VDC	15 Watts @ 24 VDC	15 Watts @ 24 VDC	18 Watts @ 24 VDC
Storage Temp.	-25 to 65°C (-13 to 149°F)				
Humidity	10-95% RH, non-condensing				
Electrical Noise	NEMA ICS 2-230 showering arc ANSI C37.90a-1974 SWC Level C Chattering Relay Test				
Withstand Voltage	1000 VDC (1 Minute), between power supply input terminal and protective ground (FG)				
Insulation Res.	Over 20 MΩ , between power supply input terminal and protective ground (FG)				
Vibration	5 to 55Hz 2G for 2 hours in the X, Y and Z axes				
Shock	10G for under 12ms in the X, Y and Z axes				
# of Screens	Up to 999 limited by memory				
Real Time Clock	Built into Panel (PLC clock is still accessible if available)				
Screen Saver	Yes, Backlight off				
Serial/Ethernet Communications	PLC port: RS-232/RS-422/RS-485 15-Pin D-Sub (female)				
Serial/Ethernet Communications Option Cards	Download/program port: RS-232/RS-422/RS-485 9-pin D-sub (female)				
	Ethernet Built-in (10/100 Base-T)				
USB & MicroSD ports	DataHighway plus (-EEH models)				
	1 USB port for programming, 1 USB port for Datalogging and 1 microSD slot for additional data storage				
External Dimensions	6.145"x8.048"x2.433" (156.078x204.407 x51.786mm)	6.145"x8.048"x2.433" (156.078x204.407 x51.786mm)	8.748"x10.894"x2.289" (222.199x276.708 x58.136mm)	10.59"x13.58"x2.86" (268.99x344.93 x72.64mm)	13.19"x10.63"x3.25" (335x270x82.5mm)
Weight	1.7 lbs	1.7 lbs	2.9 lbs	3.8 lbs	3.8 lbs
Agency Approval	UI, cUL, CE				

EZ3 Enhanced Series 15" Specifications

EZ3 Enhanced Series 15" Model Specifications

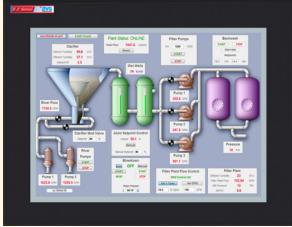
Part Number			
			EZ3-T15C-EE (Full Featured w/Ethernet) \$1999 EZ3-T15C-EEH (Serial, Ethernet and Allen-Bradley's DH+) \$3699
Specification	15" color slim bezel	Humidity	10-95% RH, noncondensing
Enclosure	NEMA 4, 4X (indoor)	Electrical Noise	NEMA ICS 2-230 showering arc ANSI C37.90a-1974 SWC Level C Chattering Relay Test
Display Type	15.0" TFT w/Built-in Anti-glare	Withstand Voltage	1000VDC (1 minute), between power supply input terminal and protective ground (FG)
Display View Area	12.02"x9.01" (305.28 x 228.96mm)	Insulation Res.	Over 20 MΩ, between power supply input and terminal and protective ground (FG)
Screen Pixels	1024x768	Vibration	5 to 55Hz 2G for 2 hours in the X, Y and Z axes
Colors	16.2M	Shock	10G for under 12ms in the X, Y and Z axes
Brightness/Life	400 nits/75,000 hours	User Memory	16GB SSD, 1GB DDR2 RAM
Touch Screen	Analog Resistive Touch	# of Screens	Up to 999 limited by memory
CPU Type	Intel Atom E640 1 GHz processor	Real Time Clock	Built into panel (PLC clock is still accessible if available)
Service Power	24VDC (20-30VDC operating range), 1.5A switching supply recommended	Screen Saver	Yes, Backlight off
Power	Back-light On	18 Watts @ 24VDC	Serial and Ethernet Communications
	Back-light Off	9 Watts @ 24VDC	
Agency Approval	UL, CUL, CE		
Operating Temp.	0 to 55°C (32 to 131°F)		Download/program port: RS-232/RS-422/RS-485 9-pin D-sub (female)
Storage Temp.	-25 to 65°C (-13 to 149°F)		Ethernet with 10/100 BaseT
External Dimensions	13"x16.75"x4.66" (332x425.25x118.36mm)		USB
		Micro SD Card Slot	4 USB 2.0 Ports (Programming, Datalogging and Peripheral devices)
		Weight	Data Logging
			7 lbs

Proudly Made in America

EZ3 Enhanced Series 6" TFT Color Panels

(Great Replacement for PanelView 550, 600 with DH+)

EZ3 Enhanced Series Touchpanel feature:

- 400 NITs, 75K Hrs @ 55°C
- 320 x 240 screen resolution
- 5.7" diagonal color TFT
- Patented HMI on-line edit, No downtime
- Tiny EZminiWifi installed on the HMI allows Laptop to program HMI from 400 ft. away. \$49
- Only HMI that can still talk to AB's DH+
- EZTouch EZ3 Enhanced HMI have real time access to process data stored inside the HMI or the USB drive and the micro SD using AVG File Manager utility.
- EZTouch EZ3 Enhanced HMI in a plant or multiple plants have the capacity to be monitored using EZPlantview software.
- Best looking objects and animation with 65K colors.
- Most Rugged 0.090" thick anti-glare touch screen.
- Unicode for multiple languages.
- Easiest Programming Software, design time in hrs not days.
- Full Project simulation on your PC.
- "C level" scripting and logic expressions.
- Data-logging, Recipes, Emails, USBs. Free Chart recorder.
- Most advanced Alarm management and logging.
- On-Screen Recipe Edit.
- Every model Fully Loaded, No "R" Reduced Features models.
- Remote Monitoring and Control, Smart phones & Ethernet.
- Communicate to all PLCs, including DH+ & Ethernet IP.
- Dual PLC Drivers with automatic tag conversion.
- Mfr. cost reduction & IP protection for qualified customers.
- Unique Visibility tag for best screen space utilization.
- Pass-through programming for all PLCs.

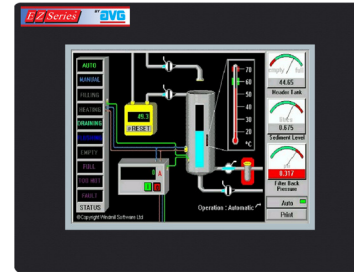

Model Number	Interface	Price	Del.
EZ3-T6C-EE	All serial and Ethernet drivers	\$599	STK
EZ3-T6C-EEH	Serial, Ethernet and Allen-Bradley's DH+	\$1499	STK

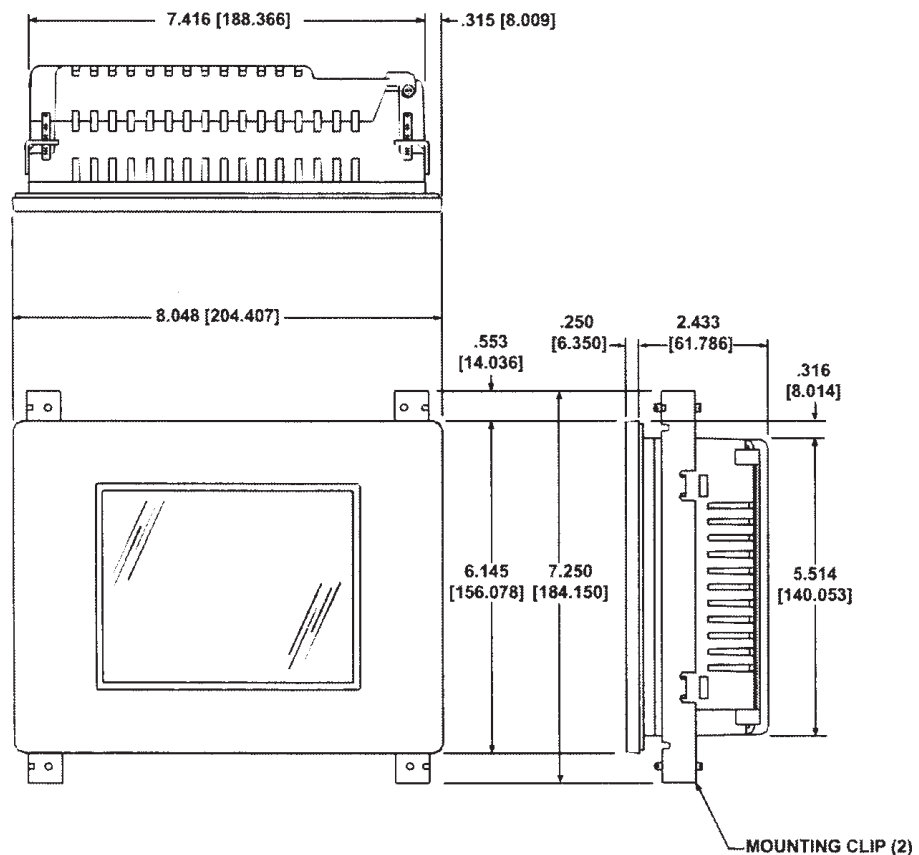

Proudly Made in America

EZ3 Enhanced Series 7" (Wide) TFT Color Panels

EZ3 Enhanced Series Touchpanel feature:

- 400 NITs, 75K Hrs @ 55°C
- 800 x 480 screen resolution
- 7" diagonal color TFT
- Patented HMI on-line edit, No downtime
- Tiny EZminiWifi installed on the HMI allows Laptop to program HMI from 400 ft. away. \$49
- EZTouch EZ3 Enhanced HMI have real time access to process data stored inside the HMI or the USB drive and the micro SD using AVG File Manager utility.
- EZTouch EZ3 Enhanced HMI in a plant or multiple plants have the capacity to be monitored using EZPlantview software.
- Best looking objects and animation with 65K colors.
- Most Rugged 0.090" thick anti-glare touch screen.
- Unicode for multiple languages.
- Easiest Programming Software, design time in hrs not days.
- Full Project simulation on your PC.
- "C level" scripting and logic expressions.
- Data-logging, Recipes, Emails, USBs. Free Chart recorder.
- Most advanced Alarm management and logging.
- On-Screen Recipe Edit.
- Every model Fully Loaded, No "R" Reduced Features models.
- Remote Monitoring and Control, Smart phones & Ethernet.
- Communicate to all PLCs.
- Dual PLC Drivers with automatic tag conversion.
- Mfr. cost reduction & IP protection for qualified customers.
- Unique Visibility tag for best screen space utilization.
- Pass-through programming for all PLCs.

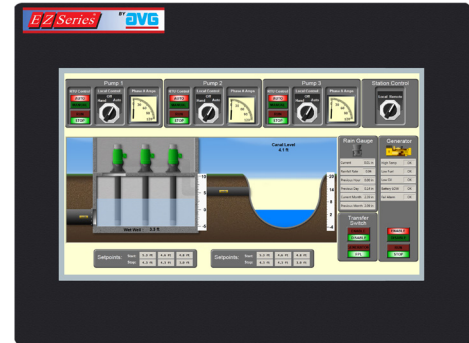

Model Number	Interface	Price	Del.
EZ3-T7C-EE	All serial and Ethernet drivers	\$549	STK

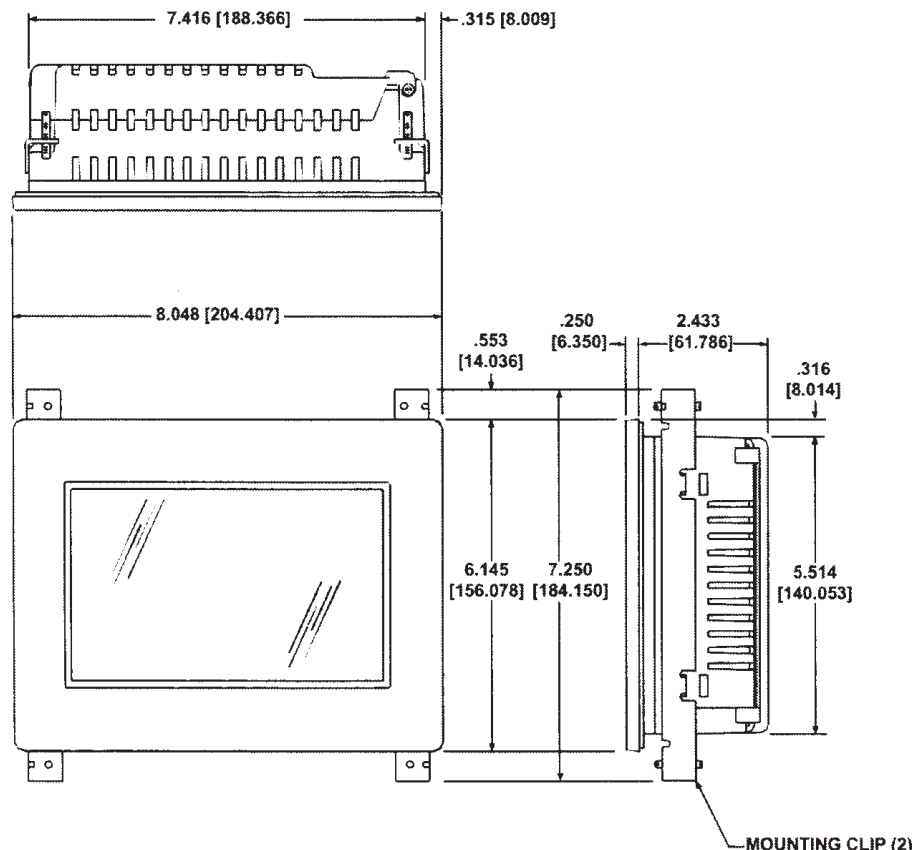

Proudly Made in America

EZ3 Enhanced Series 8" TFT Color Panels

(Great Replacement for PanelView 700, 900 with DH+)

EZ3 Enhanced Series Touchpanel feature:

- 400 NITs, 75K Hrs @ 55°C
- 800 x 600 screen resolution
- 8.4" diagonal color TFT
- Patented HMI on-line edit, No downtime
- Tiny EZminiWifi installed on the HMI allows Laptop to program HMI from 400 ft. away. \$49
- Only HMI that can still talk to AB's DH+
- EZTouch EZ3 Enhanced HMI have real time access to process data stored inside the HMI or the USB drive and the micro SD using AVG File Manager utility.
- EZTouch EZ3 Enhanced HMI in a plant or multiple plants have the capacity to be monitored using EZPlantview software.
- Best looking objects and animation with 65K colors.
- Most Rugged 0.090" thick anti-glare touch screen.
- Unicode for multiple languages.
- Easiest Programming Software, design time in hrs not days.
- Full Project simulation on your PC.
- "C level" scripting and logic expressions.
- Data-logging, Recipes, Emails, USBs. Free Chart recorder.
- Most advanced Alarm management and logging.
- On-Screen Recipe Edit.
- Every model Fully Loaded, No "R" Reduced Features models.
- Remote Monitoring and Control, Smart phones & Ethernet.
- Communicate to all PLCs, including DH+ & Ethernet IP.
- Dual PLC Drivers with automatic tag conversion.
- Mfr. cost reduction & IP protection for qualified customers.
- Unique Visibility tag for best screen space utilization.
- Pass-through programming for all PLCs.

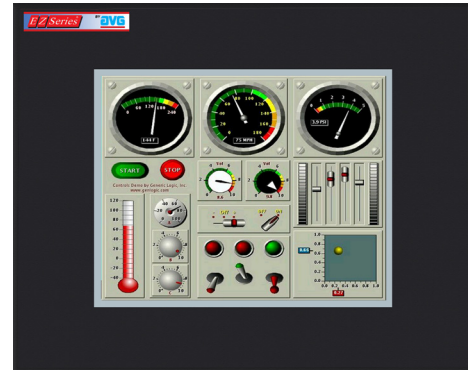

Model Number	Interface	Price	Del.
EZ3-T8C-EE	All serial and Ethernet drivers	\$1049	STK
EZ3-T8C-EEH	Serial, Ethernet and Allen-Bradley's DH+	\$2299	STK

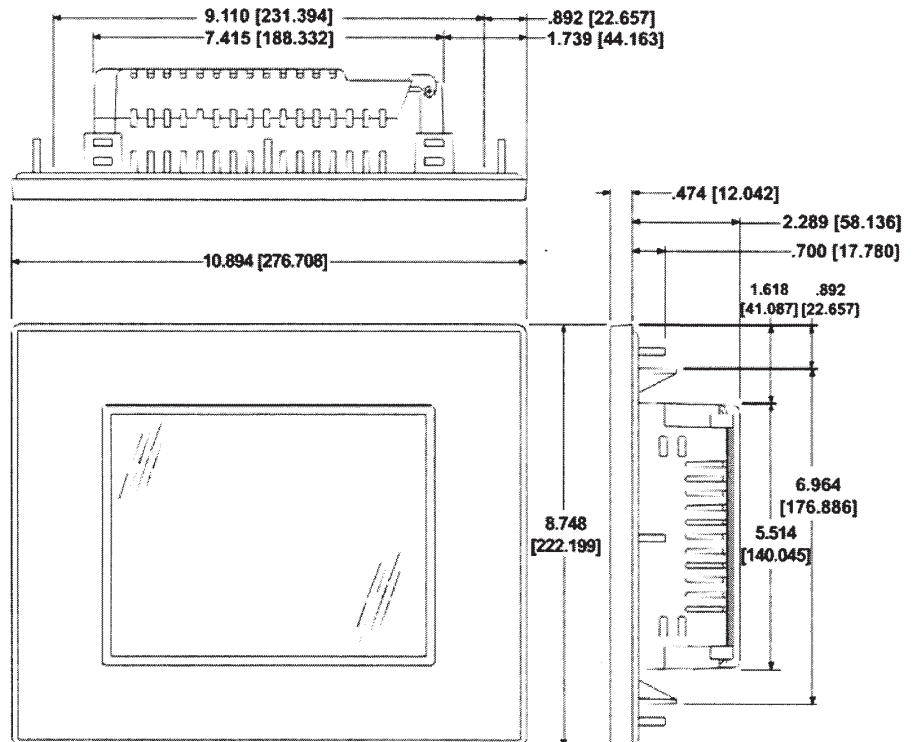

Proudly Made in America

EZ3 Enhanced Series 10" TFT Color Panels (Great Replacement for PanelView 1000, 1000E with DH+)

EZ3 Enhanced Series Touchpanel feature:

- 400 NITs, 75K Hrs @ 55°C
- 800 x 600 screen resolution
- 10.4" diagonal color TFT
- Patented HMI on-line edit, No downtime
- Tiny EZminiWifi installed on the HMI allows Laptop to program HMI from 400 ft. away. \$49
- Only HMI that can still talk to AB's DH+
- EZTouch EZ3 Enhanced HMI have real time access to process data stored inside the HMI or the USB drive and the micro SD using AVG File Manager utility.
- EZTouch EZ3 Enhanced HMI in a plant or multiple plants have the capacity to be monitored using EZPlantview software.
- Best looking objects and animation with 65K colors.
- Most Rugged 0.090" thick anti-glare touch screen.
- Unicode for multiple languages.
- Easiest Programming Software, design time in hrs not days.
- Full Project simulation on your PC.
- "C level" scripting and logic expressions.
- Data-logging, Recipes, Emails, USBs. Free Chart recorder.
- Most advanced Alarm management and logging.
- On-Screen Recipe Edit.
- Every model Fully Loaded, No "R" Reduced Features models.
- Remote Monitoring and Control, Smart phones & Ethernet.
- Communicate to all PLCs, including DH+ & Ethernet IP.
- Dual PLC Drivers with automatic tag conversion.
- Mfr. cost reduction & IP protection for qualified customers.
- Unique Visibility tag for best screen space utilization.
- Pass-through programming for all PLCs.

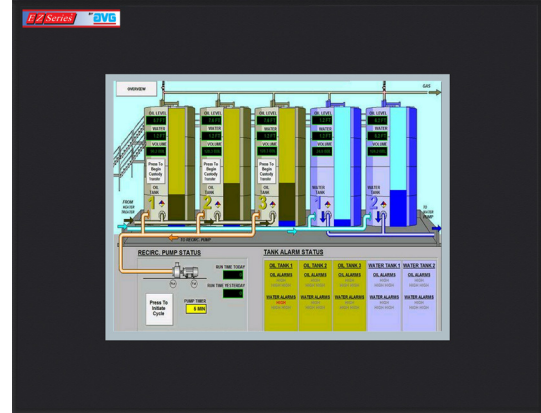

Model Number	Interface	Price	Del.
EZ3-T10C-EE	All serial and Ethernet drivers	\$1349	STK
EZ3-T10C-EEH	Serial, Ethernet and Allen-Bradley's DH+	\$2999	STK

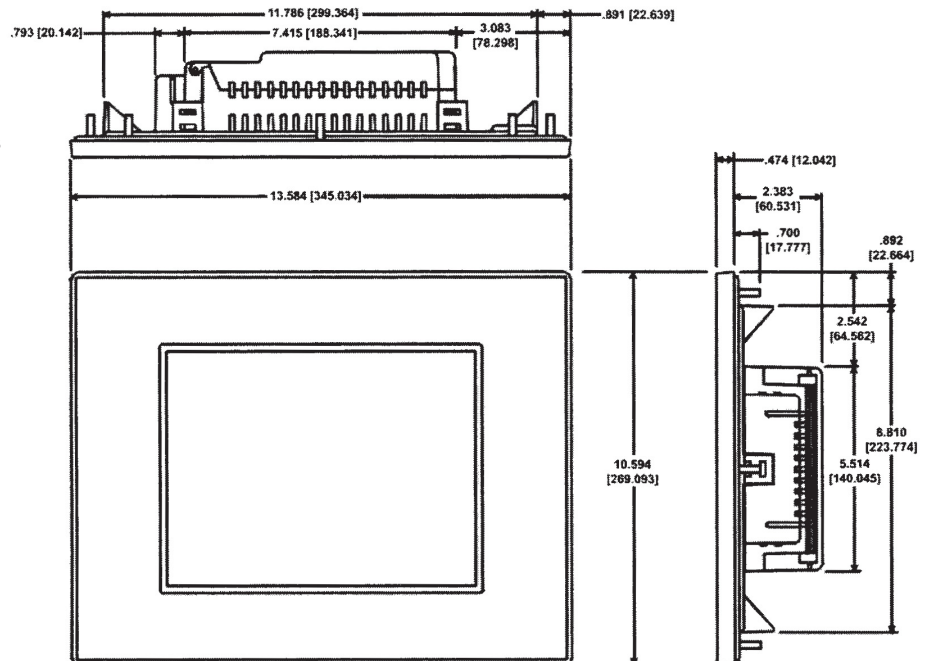

Proudly Made in America

EZ3 Enhanced Series 12" TFT Color Panels (Great Replacement for PanelView 1000, 1000E with DH+)

EZ3 Enhanced Series Touchpanel feature:

- 300 NITs, 50K Hrs @ 55°C
- 800 x 600 screen resolution
- 12" diagonal color TFT
- Patented HMI on-line edit, No downtime
- Tiny EZminiWifi installed on the HMI allows Laptop to program HMI from 400 ft. away.
- Only HMI that can still talk to AB's DH+
- EZTouch EZ3 Enhanced HMI have real time access to process data stored inside the HMI or the USB drive and the micro SD using AVG File Manager utility.
- EZTouch EZ3 Enhanced HMI in a plant or multiple plants have the capacity to be monitored using EZPlantview software.
- Best looking objects and animation with 65K colors.
- Most Rugged 0.090" thick anti-glare touch screen.
- Unicode for multiple languages.
- Easiest Programming Software, design time in hrs not days.
- Full Project simulation on your PC.
- "C level" scripting and logic expressions.
- Data-logging, Recipes, Emails, USBs. Free Chart recorder.
- Most advanced Alarm management and logging.
- On-Screen Recipe Edit.
- Every model Fully Loaded, No "R" Reduced Features models.
- Remote Monitoring and Control, Smart phones & Ethernet.
- Communicate to all PLCs, including DH+ & Ethernet IP.
- Dual PLC Drivers with automatic tag conversion.
- Mfr. cost reduction & IP protection for qualified customers.
- Unique Visibility tag for best screen space utilization.
- Pass-through programming for all PLCs.

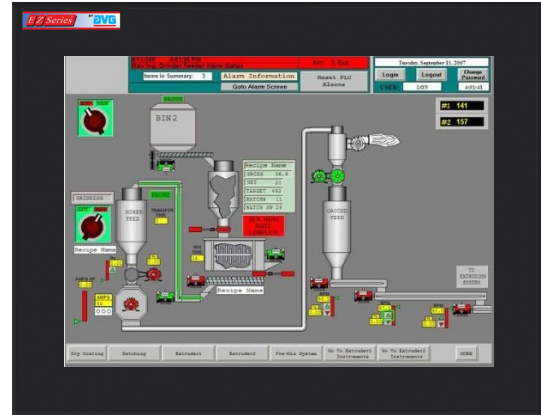

Model Number	Interface	Price	Del.
EZ3-T12C-EE	All serial and Ethernet drivers	\$1499	STK

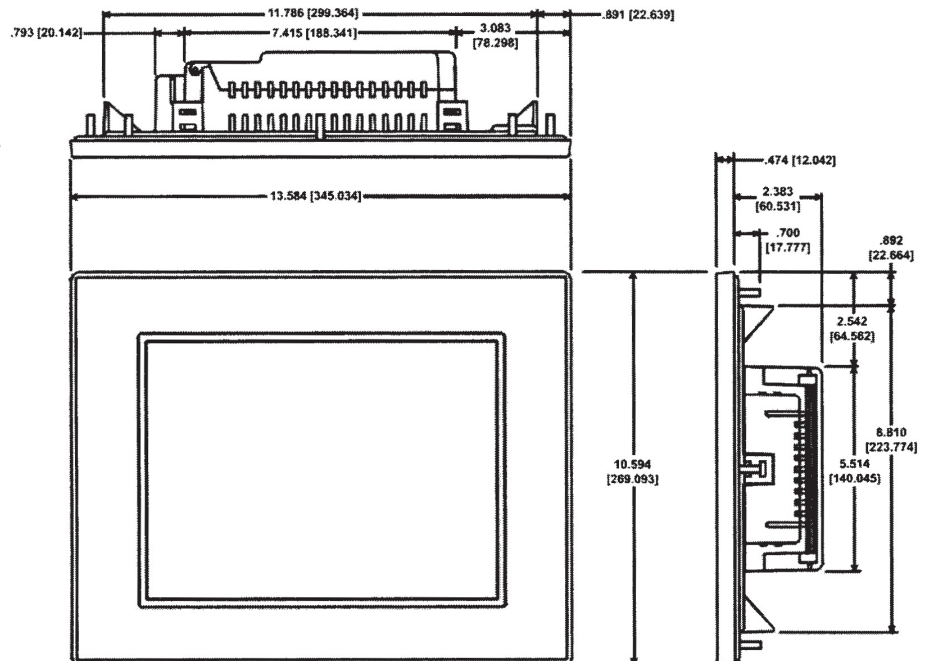

Proudly Made in America

EZ3 Enhanced Series 15" TFT Color Panels

(Great Replacement for PanelView 1200, 1400, 1400E with DH+)

EZ3 Enhanced Series Touchpanel feature:

- 400 NITs, 75K Hrs @ 55°C
- 1024 x 768 screen resolution
- 15" diagonal color TFT
- Patented HMI on-line edit, No downtime
- Tiny EZminiWifi installed on the HMI allows Laptop to program HMI from 400 ft. away. \$49
- Only HMI that can still talk to AB's DH+
- EZTouch EZ3 Enhanced HMI have real time access to process data stored inside the HMI or the USB drive and the micro SD using AVG File Manager utility.
- EZTouch EZ3 Enhanced HMI in a plant or multiple plants have the capacity to be monitored using EZPlantview software.
- 1024x768 resolution
- 1 GB Ethernet Port for Programming, Webserver access and PLC Communications
- 4 USB 2.0 Ports, including 1 for programming
- MicroSD Card capable
- Intel Atom E640 1 GHz processor
- 1GB DDR RAM
- Best looking objects and animation with 65K colors.
- Most Rugged 0.090" thick anti-glare touch screen.
- Unicode for multiple languages.
- Easiest Programming Software, design time in hrs not days.
- Full Project simulation on your PC.
- "C level" scripting and logic expressions.
- Data-logging, Recipes, Emails, USBs. Free Chart recorder.
- Most advanced Alarm management and logging.
- On-Screen Recipe Edit.
- Every model Fully Loaded, No "R" Reduced Features models.
- Remote Monitoring and Control, Smart phones & Ethernet.
- Communicate to all PLCs, including DH+ & Ethernet IP.
- Dual PLC Drivers with automatic tag conversion.
- Mfr. cost reduction & IP protection for qualified customers.
- Unique Visibility tag for best screen space utilization.
- Pass-through programming for all PLCs.

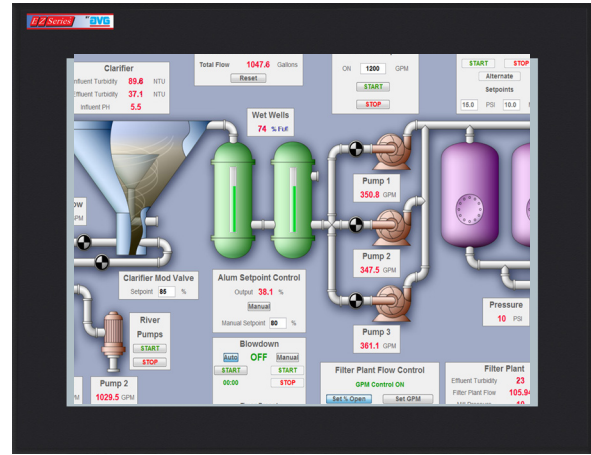

Model Number	Interface	Price	Del.
EZ3-T15C-EE	All serial and Ethernet drivers	\$1999	STK
EZ3-T15C-EEH	Serial, Ethernet and Allen-Bradley's DH+	\$3699	STK

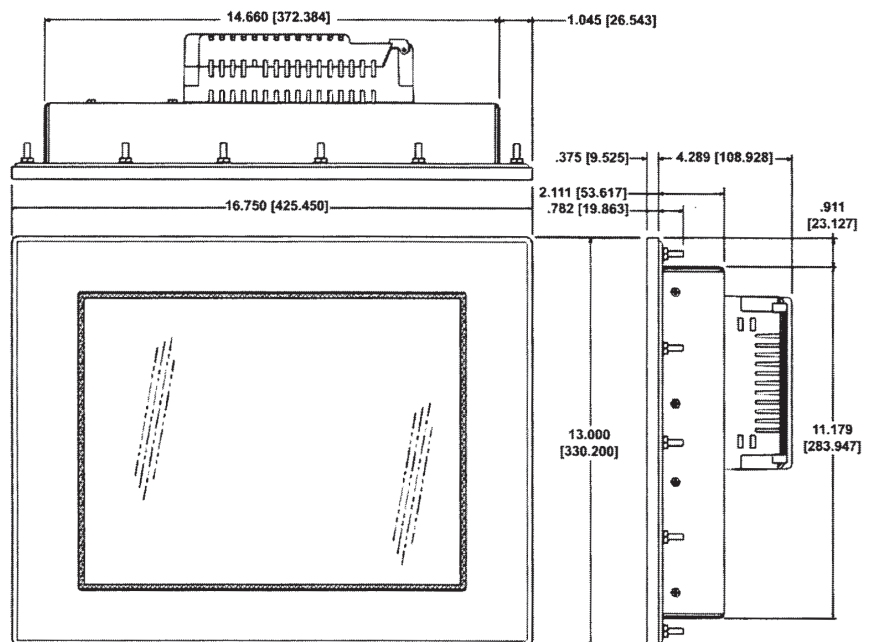

Proudly Made in America